

NASA TECHNICAL NOTE



NASA TN D-5104

C. 1

NASA TN D-5104



LOAN COPY: RETURN TO
AFWL (WLIL-2)
KIRTLAND AFB, N MEX

INVESTIGATION OF OCCULTATION AND IMAGERY PROBLEMS FOR ORBITAL MISSIONS TO VENUS AND MARS

by Richard N. Green

Langley Research Center

Langley Station, Hampton, Va.



INVESTIGATION OF OCCULTATION AND IMAGERY PROBLEMS
FOR ORBITAL MISSIONS TO VENUS AND MARS

By Richard N. Green

Langley Research Center
Langley Station, Hampton, Va.

NATIONAL AERONAUTICS AND SPACE ADMINISTRATION

For sale by the Clearinghouse for Federal Scientific and Technical Information
Springfield, Virginia 22151 - CFSTI price \$3.00

INVESTIGATION OF OCCULTATION AND IMAGERY PROBLEMS FOR ORBITAL MISSIONS TO VENUS AND MARS

By Richard N. Green
Langley Research Center

SUMMARY

A computer program for the purpose of providing mission design data for planetocentric elliptical orbits about either Mars or Venus has been developed. The times at which the satellite enters into and exits from the shadows of the Sun, Earth, and Canopus are computed. In addition, the positions in orbit that correspond to desirable lighting conditions on the surface for vertical photography are computed. A program option allows for these conditions to be examined at various times by permitting the planet to proceed in its orbit about the Sun. The mean heliocentric position of the planet, the angles in the Earth-Sun-planet triangle, and the associated distances are also included in the list of output parameters. The program is written in FORTRAN IV language for a digital computer and contains 27 subroutines of general use. A description of the program input and output, a complete FORTRAN listing of the program, and samples of the input and output are included.

INTRODUCTION

The computer program VAMOOS (Venus and Mars Orbital Occultation Simulator) originated for the purpose of studying orbital missions to Mars and Venus. Two important considerations to mission analysis are the occultations of celestial bodies and the available imagery. The length of time that the satellite spends in the shadows of the Sun, Earth, and Canopus is significant. When the satellite passes into the shadow of the Sun, the use of solar cells is prohibited. Many times this condition is undesirable or must be limited to short periods of darkness. Passage into the shadow of the Earth will result in the loss of communication between the satellite and Earth. Since the attitude reference system of the satellite is frequently aligned with the Sun and Canopus, the occultation of either is of great interest. In addition to the importance of the length of time, the positions in the orbit at which the satellite enters into and exits from the shadows are significant since they influence the operational sequence of events. The positions in the orbit of the satellite that correspond to desirable lighting conditions on the surface of the planet for vertical photography are also of interest. These positions, along with the orbital

elements, lead to the definition of the surface which can be photographed. In addition, the resulting resolution is defined. If the mission objectives require that specific sections of the planet's surface be photographed, the orientation of the orbital plane of the satellite can be adjusted to satisfy the objectives. For these reasons VAMOOS was developed to supply the data necessary to define the occultations and the conditions at specific lighting angles.

The program is based on the assumption that the hyperbolic arrival conditions at the planet are known. The hyperbolic excess velocity and the arrival asymptote for a given arrival Julian date are generally available (refs. 1 and 2) or can be generated with Lambert's theorem and the appropriate ephemerides. To establish an elliptical orbit about the planet, a deboost from a hyperbolic periapsis to an elliptical periapsis was assumed, and this assumption should not be restrictive for preliminary mission design. Occultation and imagery parameters within the orbit are then generated. The calculations have been greatly simplified by fixing the celestial bodies during one spacecraft revolution. This simplification is valid since the angular displacement of the planet in its orbit about the Sun is small for a period of a few hours. A program option allows the investigator to examine future conditions by stepping the planet in time within its orbit about the Sun. The second zonal harmonic J_{20} can be incorporated in these calculations to perturb the argument of periapsis and the longitude of the ascending node of the satellite orbit by the appropriate input.

In an attempt to make the program a useful analytical tool, emphasis has been placed on the speed and simplicity of the calculations. Keplerian mechanics and analytic solutions were used entirely throughout the program to make the calculations as rapid as possible. The mean heliocentric positions of Venus, Earth, and Mars are generated with mean orbital elements. The calculation sequence has been divided into a number of separate calculations which form the subroutines of the program. This modular form should facilitate the understanding of the many calculations performed.

The necessary information pertaining to the implementation of the program is contained in the appendixes of this paper. The function of the main program is outlined with a flow diagram and the purpose of each subroutine is set forth (appendix A). A complete FORTRAN listing is included (appendix B) in addition to a sample input and output case (appendix C).

SYMBOLS

- | | |
|-----|-------------------------------------|
| a | semimajor axis, kilometers |
| A,B | angles defined by figure 5, degrees |

AU	astronomical unit, kilometers
C_0, C_1, C_2, C_3, C_4	coefficients of a polynomial
\vec{d}	vector defined by figure 7
d	magnitude of \vec{d}
D	Julian days since 1900
$\tilde{D} = \frac{D}{10\,000}$	
e	eccentricity
\vec{E}	unit vector from planet toward a celestial body
F, G, H, I	angles defined in figure 2, degrees
f	true anomaly, degrees
h_a	apoapsis altitude, kilometers
h_p	periapsis altitude, kilometers
i	inclination, degrees
$\vec{i}, \vec{j}, \vec{k}$	unit coordinate vectors
JD	Julian date, days
J_{20}	second zonal harmonic of planet
l	semilatus rectum, kilometers
M	mean anomaly, degrees
n	mean angular rate, radians/second
P, Q, R	points in spherical triangle (see fig. 2)

$\vec{P}, \vec{Q}, \vec{W}$	unit coordinate vectors in PQW coordinate system; \vec{P} points toward peria- apsis, \vec{Q} is in orbital plane advanced to \vec{P} by a right angle in direction of increasing true anomaly, and \vec{W} completes right-handed system
R	rotational matrix from mean Earth equinox and equator of date coordinate system to mean planet equinox and equator of date coordinate system
RPQW	rotational matrix from XYZ TO PQW coordinate system
\vec{r}	radius vector
r	magnitude of \vec{r}
r_s	surface radius of planet, kilometers
\vec{S}	unit vector from center of planet parallel to arrival asymptote of incoming hyperbola
S	magnitude of \vec{S}
t	whole number of Julian years since 1950
t'	time past deboost, seconds
T_e	Julian centuries since 1900
V	velocity, kilometers/second
X,Y,Z	rectangular Cartesian coordinates
α	right ascension of axis of rotation of planet referenced to mean Earth equinox and equator of date coordinate system, degrees
β	orbital plane orientation angle, degrees (see fig. 1)
γ	declination of axis of rotation of planet referenced to mean Earth equinox and equator of data coordinate system, degrees
δ	declination, degrees
Δ	angle defined by figure 2, degrees

ϵ	mean obliquity of ecliptic, degrees
λ	right ascension, degrees
μ	gravitational constant, kilometers ³ /second ²
τ	$[100T_e]$, where $[X]$ is fractional part of X , years
Υ	first point of Aries
ϕ	angle between \vec{S} and \vec{P} , degrees
ψ	angle between planet-Sun vector and planet-satellite radius vector, degrees
Ω	longitude of ascending node, degrees
ω	argument of periapsis, degrees

Subscripts:

C	denotes star Canopus
EC	measured in mean Earth equinox and ecliptic of date coordinate system
EE	measured in mean Earth equinox and equator of date coordinate system
f	first value
h	denotes hyperbolic orbit
l	last value
P	denotes planet Venus or Mars
PE	measured in mean planet equinox and equator of date coordinate system
p,q,w	rectangular Cartesian components in PQW coordinate system
px,py,pz	rectangular Cartesian components in mean planet equinox and equator of date coordinate system

S	denotes \vec{S}
1,2	first and second root of an equation
∞	infinity
\odot	denotes Sun
\ominus	denotes Venus
\oplus	denotes Earth
$\♂$	denotes Mars
o	initial conditions

Dot over symbol denotes derivative with respect to time.

METHOD OF CALCULATION

The hyperbolic arrival conditions at the planet are inputs to the program. These inputs include such quantities as the arrival Julian date, the right ascension and declination of the S-vector expressed in the Earth equatorial coordinate system and the hyperbolic excess velocity. The S-vector is identical to the unit vector from the center of the planet parallel to the arrival asymptote of the incoming hyperbola. The size of the planet-ocentric ellipse must also be included in the form of the apoapsis and the periapsis altitudes. Since the orbital plane can be rotated about the S-vector with only small expenditures of fuel, the orientation of the orbital plane is considered to be an independent variable and is at the discretion of the investigator. The plane is restricted, however, to contain the S-vector, but can assume any inclination that fulfills this requirement. The angle β (fig. 1) has been taken as a measure of the orientation. The program allows for this angle to be incremented through any range of interest from 0° to 360° . For a given β the computation of Keplerian orbital elements is based on a deboost from a hyperbolic periapsis to an elliptical periapsis. Imagery data and occultation data based on the positions of the celestial bodies at the time of periapsis passage are then generated.

Hyperbolic Arrival Conditions

The hyperbolic arrival conditions at the planet for a given Julian date as obtained from references 1 and 2 are expressed in a coordinate system oriented to the mean Earth

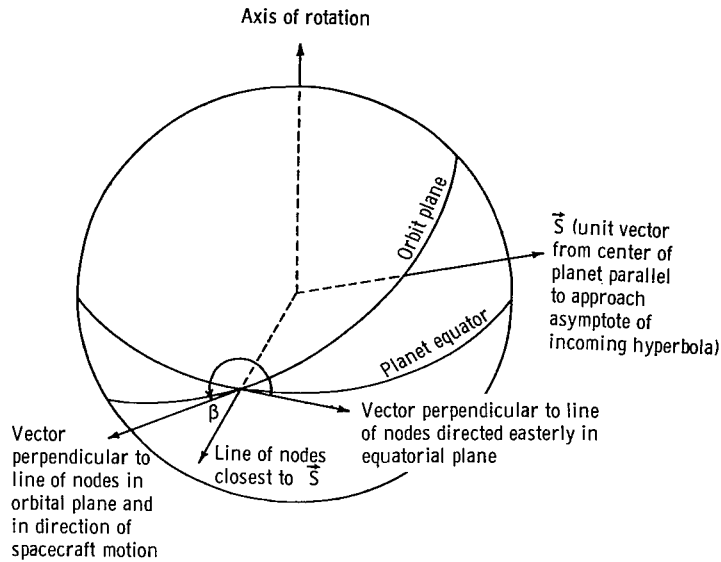

Figure 1.- Orbital plane geometry. (β is measured counterclockwise in plane perpendicular to line of nodes.)

equinox and equator. Since it is desirable to perform all the orbital calculations in a coordinate system oriented to the mean planet equinox and equator, the transformation between the two systems is necessary.

Consider figure 2 where α and γ are the right ascension and declination of the planet's axis of rotation, respectively, expressed in the Earth coordinate system. For Venus (ref. 3, p. 20),

$$\alpha_{\text{♀}} = 272^{\circ}.75$$

$$\gamma_{\text{♀}} = 71^{\circ}.50$$

and for Mars (ref. 4, p. 334),

$$\alpha_{\text{♂}} = 317^{\circ}.793416667 + 0^{\circ}.006520833t - 0^{\circ}.001013\tau$$

$$\gamma_{\text{♂}} = 54^{\circ}.6575000 + 0^{\circ}.0035t - 0^{\circ}.000631\tau$$

where

$$T_e = \frac{JD - 2\,415\,020}{36\,525}$$

$$\tau = [100T_e] \text{ where } [X] \text{ is the fractional part of } X$$

$$t = 100T_e - \tau - 50$$

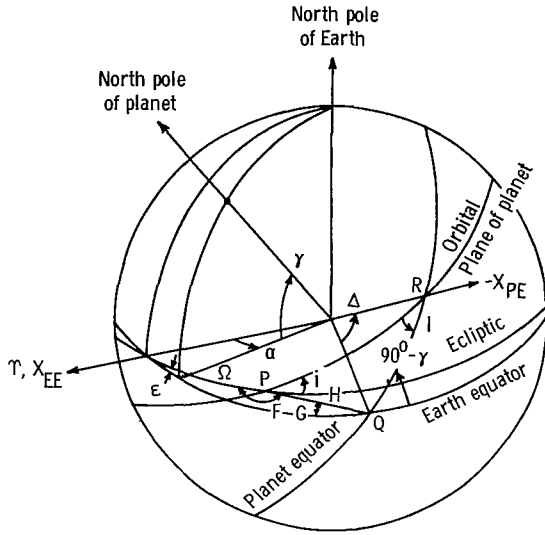

Figure 2.- Geometry of transformation from the Earth equator to the planet equator system.

and JD is the Julian date at the time of interest. The longitude of the ascending node of the Venus orbital plane on the ecliptic and the inclination of the Venus orbital plane to the ecliptic is (ref. 4, p. 113)

$$\Omega_{\text{V}} = 75^{\circ}46'46''.73 + 3239''.46T_e + 1''.476T_e^2$$

$$i_{\text{V}} = 3^{\circ}23'37''.07 + 3''.621T_e - 0''.0035T_e^2$$

For Mars (ref. 4, p. 335)

$$\Omega_{\text{M}} = 48^{\circ}47'11''.19 + 2775''.57T_e - 0''.005T_e^2$$

$$i_{\text{M}} = 1^{\circ}51'01''.20 - 2''.430T_e + 0''.0454T_e^2$$

The mean obliquity of the ecliptic ϵ is given by (ref. 4, p. 98)

$$\epsilon = 23^{\circ}27'8''.26 - 46''.845T_e - 0''.0059T_e^2 + 0''.00181T_e^3$$

The rotation from the Earth equatorial system to the planet equatorial coordinate system is given in reference 4 (p. 330). It can be seen that this rotation is essentially

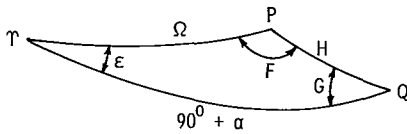

Figure 3.- Spherical triangle defined in figure 2.

an Euler rotation where the X-axis is rotated from T to Q along the Earth equatorial plane and followed by a rotation about Q through the angle $90^{\circ} - \gamma$, and finally the X-axis is rotated along the planet's equatorial plane to the ascending node of the orbital plane on its equatorial plane. The angle TQ is immediately seen to be $\alpha + 90^{\circ}$, and the rotation about Q is

$90^{\circ} - \gamma$. The only angle remaining to be calculated is Δ which necessitates the solution of two spherical triangles. Consider the triangle TQP as shown in figure 3. The angles F , G , and H are computed by

$$\cos H = \cos \Omega \cos(90^{\circ} + \alpha) + \sin \Omega \sin(90^{\circ} + \alpha) \cos \epsilon$$

$$\sin H = \sqrt{1 - \cos^2 H}$$

$$\cos F = \frac{\cos(90^{\circ} + \alpha) \sin \Omega - \sin(90^{\circ} + \alpha) \cos \Omega \cos \epsilon}{\sin H}$$

$$\sin F = \frac{\sin \epsilon \sin(90^{\circ} + \alpha)}{\sin H}$$

$$\cos G = \frac{\cos \Omega \sin(90^\circ + \alpha) - \sin \Omega \cos(90^\circ + \alpha) \cos \epsilon}{\sin H}$$

$$\sin G = \frac{\sin \Omega \sin \epsilon}{\sin H}$$

Now, consider the triangle PQR (fig. 4): The angle I is given by

$$\begin{aligned} \cos I &= -\cos(180^\circ - F + i) \cos(90^\circ - G + \gamma) \\ &\quad + \sin(180^\circ - F + i) \sin(90^\circ - G + \gamma) \cos H \end{aligned}$$

$$\sin I = \sqrt{1 - \cos^2 I}$$

and the angle Δ by

$$\sin \Delta = \frac{\sin(180^\circ - F + i) \sin H}{\sin I}$$

$$\cos \Delta = \frac{\cos(180^\circ - F + i) \sin(90^\circ - G + \gamma) + \sin(180^\circ - F + i) \cos(90^\circ - G + \gamma) \cos H}{\sin I}$$

$$\Delta = \tan^{-1} \left(\frac{\sin \Delta}{\cos \Delta} \right)$$

Therefore, the three Euler angles $(90^\circ + \alpha, 90^\circ - \gamma, \Delta + 180^\circ)$ constitute the Euler rotation R which transforms the \vec{S} from the Earth equatorial to the planet equatorial system, that is

$$\vec{S}_{PE} = R \vec{S}_{EE}$$

where

$$R = \begin{bmatrix} \cos(\Delta + 180^\circ) \cos(90^\circ + \alpha) & \cos(\Delta + 180^\circ) \sin(90^\circ + \alpha) & \sin(\Delta + 180^\circ) \sin(90^\circ - \gamma) \\ -\cos(90^\circ - \gamma) \sin(90^\circ + \alpha) \sin(\Delta + 180^\circ) & +\cos(90^\circ - \gamma) \cos(90^\circ + \alpha) \sin(\Delta + 180^\circ) & \\ -\sin(\Delta + 180^\circ) \cos(90^\circ + \alpha) & -\sin(\Delta + 180^\circ) \sin(90^\circ + \alpha) & \cos(\Delta + 180^\circ) \sin(90^\circ - \gamma) \\ -\cos(90^\circ - \gamma) \sin(90^\circ + \alpha) \cos(\Delta + 180^\circ) & +\cos(90^\circ - \gamma) \cos(90^\circ + \alpha) \cos(\Delta + 180^\circ) & \\ \sin(90^\circ - \gamma) \sin(90^\circ + \alpha) & -\sin(90^\circ - \gamma) \cos(90^\circ + \alpha) & \cos(90^\circ - \gamma) \end{bmatrix}$$

and

$$\vec{S}_{EE} = (\cos \delta_{S,EE} \cos \lambda_{S,EE}, \cos \delta_{S,EE} \sin \lambda_{S,EE}, \sin \delta_{S,EE})$$

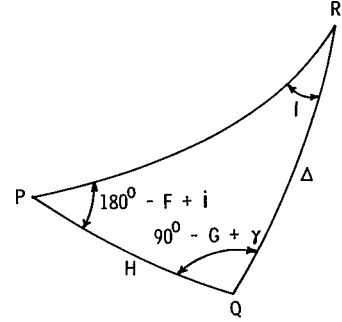

Figure 4.- Angle relationships of spherical triangle defined in figure 2.

Orbital Transfer to Planetocentric Ellipse and

Orbital Perturbations With Time

If the characteristics of the incoming hyperbolic orbit in the planet equatorial system (\vec{S}_{PE}, V_∞), the shape of the desired elliptical orbit about the planet (h_p, h_a), and the orientation angle β are known, the Keplerian orbital elements can be determined for a transfer from a hyperbolic periapsis to an elliptical periapsis. If

$$\vec{S}_{PE} = (S_{px}, S_{py}, S_{pz})$$

then the right ascension and declination of the \vec{S}_{PE} are, respectively.

$$\sin \lambda_{S,PE} = \frac{S_{py}}{\sqrt{S_{px}^2 + S_{py}^2}}$$

$$\cos \lambda_{S,PE} = \frac{S_{px}}{\sqrt{S_{px}^2 + S_{py}^2}}$$

$$\lambda_{S,PE} = \tan^{-1} \left(\frac{\sin \lambda_{S,PE}}{\cos \lambda_{S,PE}} \right)$$

and

$$\delta_{S,PE} = \sin^{-1}(S_{pz}) \quad (-90^\circ \leq \delta_{S,PE} \leq 90^\circ)$$

The semimajor axis and the eccentricity of the elliptical orbit are given by

$$a = \frac{2r_s + h_a + h_p}{2}$$

$$e = \frac{r_s + h_a}{a} - 1$$

where r_s is the surface radius of the planet.

Consider figure 5. From figure 5 it can be seen that

$$A = \sin^{-1} \left(\frac{\tan \delta_{S,PE}}{|\tan \beta|} \right) \quad (-90^\circ \leq A \leq 90^\circ)$$

$$B = \sin^{-1} \left(\frac{\sin \delta_{S,PE}}{|\sin \beta|} \right) \quad (-90^\circ \leq B \leq 90^\circ)$$

The angle ϕ between the vector \vec{S} and the vector to the periapsis \vec{P} can be found by considering the geometry of the incoming hyperbola where the orbit is defined by

$$r = \frac{a_h(1 - e_h^2)}{1 + e_h \cos f} \quad (a_h < 0; \quad e_h > 1) \quad (1)$$

As the radius r approaches infinity, the denominator must approach zero, or

$$1 + e_h \cos f_\infty = 0$$

which can be solved for the cosine of the true anomaly,

$$\cos f_\infty = -\frac{1}{e_h}$$

From figure 6 it can be seen that

$$f_\infty = 180^\circ - \phi$$

so that

$$\cos f_\infty = -\cos \phi$$

The two expressions for the $\cos f_\infty$ can be used to obtain

$$\cos \phi = \frac{1}{e_h} \quad (2)$$

Evaluating equation (1) at a true anomaly of zero gives

$$r_s + h_p = a_h(1 - e_h)$$

or

$$e_h = 1 - \frac{r_s + h_p}{a_h} \quad (3)$$

The semimajor axis of the hyperbola can be expressed in terms of known parameters by evaluating the relation

$$v^2 = \mu \left(\frac{2}{r} - \frac{1}{a_h} \right)$$

as r approaches infinity; that is,

$$a_h = \frac{-\mu}{v_\infty^2} \quad (4)$$

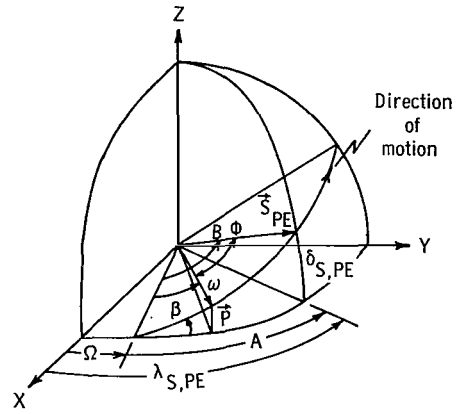

Figure 5.- Orbital transfer geometry.

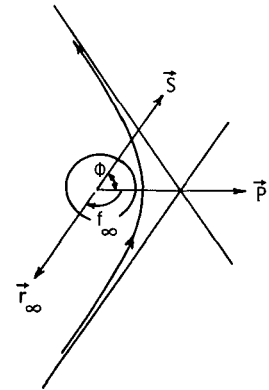

Figure 6.- Geometry of hyperbolic orbit.

Equation (2) can now be expressed in terms of known parameters by equations (3) and (4) as

$$\cos \phi = \frac{\mu}{\mu + (r_s + h_p)V_\infty^2} \quad (0^\circ \leq \phi \leq 180^\circ)$$

The inclination defined between 0° and 180° at the ascending node is given by

$$\begin{aligned} i &= \beta & (0^\circ \leq \beta \leq 180^\circ) \\ i &= 360^\circ - \beta & (180^\circ < \beta < 360^\circ) \end{aligned}$$

The argument of periapsis and the longitude of the ascending node can be determined by considering the geometry; that is,

$$\left. \begin{aligned} \omega &= B - \phi \\ \Omega &= \lambda_{S,PE} - A \end{aligned} \right\} \quad (0^\circ < \beta < 90^\circ)$$

or

$$\left. \begin{aligned} \omega &= B - \phi \\ \Omega &= \lambda_{S,PE} + A \end{aligned} \right\} \quad (90^\circ < \beta < 180^\circ)$$

and

$$\left. \begin{aligned} \omega &= 180^\circ - B - \phi \\ \Omega &= 180^\circ + \lambda_{S,PE} - A \end{aligned} \right\} \quad (180^\circ < \beta < 270^\circ)$$

or

$$\left. \begin{aligned} \omega &= 180^\circ - B - \phi \\ \Omega &= 180^\circ + \lambda_{S,PE} + A \end{aligned} \right\} \quad (270^\circ < \beta < 360^\circ)$$

Therefore, the planetocentric ellipse is defined by the Keplerian orbital elements a , e , i , ω , and Ω for a transfer from one periapsis to the other.

As the planet proceeds in its orbit about the Sun, the longitude of the ascending node and the argument of periapsis are perturbed by the second zonal harmonic J_{20} . These two orbital elements are expressed as functions of time as (ref. 5)

$$\Omega = \Omega_0 + \dot{\Omega}t'$$

$$\omega = \omega_0 + \dot{\omega}t'$$

where

$$\dot{\Omega} = -\frac{3}{2} J_2 n \left(\frac{r_s}{a}\right)^2 \frac{\cos i}{(1 - e^2)^2}$$

$$\dot{\omega} = 3J_2 n \left(\frac{r_s}{a}\right)^2 \frac{1}{(1 - e^2)^2} \left(1 - \frac{5}{4} \sin^2 i\right)$$

and

$$n = \left(\frac{\mu}{a^3}\right)^{1/2}$$

The elements Ω_0 and ω_0 are the orbital elements at the time of deboost into the planetocentric ellipse and t' is the time past deboost in seconds.

The gravitational constant and the radius of the planet are necessary in calculations involving the orbital elements and their perturbations with time. The gravitational constants for Venus and Mars are given by (ref. 6, p. 8)

$$\mu_{\text{♀}} = 3.2485340 \times 10^5 \text{ km}^3/\text{sec}^2$$

$$\mu_{\text{♂}} = 4.297780 \times 10^4 \text{ km}^3/\text{sec}^2$$

and the surface radius of Venus is (ref. 3, p. 18)

$$r_{s_{\text{♀}}} = 6085 \text{ km}$$

and the surface radius of Mars is (ref. 7, p. 24)

$$r_{s_{\text{♂}}} = 3395 \text{ km}$$

Satellite Occultation of Celestial Bodies

Before the positions in the orbit at which the satellite enters and exits the shadows of the celestial bodies can be computed, the unit vectors from the planet toward the celestial bodies must be found. These vectors are found by considering the mean orbital elements of the planets about the Sun which lead to the heliocentric position vectors of the planets. The proper addition of these vectors will yield the desired vectors. Let

$$D = \text{JD} - 2\,415\,020$$

$$\tilde{D} = \frac{D}{10\,000}$$

since the mean orbital elements are referenced to the mean equinox and ecliptic of 1900. The value of the astronomical unit in units of kilometers is given by (ref. 8, p. 6)

$$\text{AU} = 149\,598\,845 \text{ km}$$

and the gravitational constant of the Sun is (ref. 6, p. 8)

$$\mu_{\odot} = 1.32715445 \times 10^{11} \text{ km}^3/\text{sec}^2$$

Since the mean orbital elements of the Sun about the Earth (ref. 4, p. 98) are similar to the orbital elements of the Earth about the Sun, the semimajor axis is

$$a_{\oplus} = 1.00000023\text{AU}$$

The eccentricity is

$$e_{\oplus} = 0.01675104 - 0.00004180T_e - 0.000000126T_e^2$$

The longitude of periapsis is

$$\omega_{\oplus} = 101^{\circ}.220833 + 0^{\circ}.000047068D + 0^{\circ}.0000339\tilde{D}^2$$

and the mean anomaly is

$$M_{\oplus} = 358^{\circ}.475845 + 0^{\circ}.9856002670D - 0^{\circ}.0000112\tilde{D}^2 - 0^{\circ}.00000007\tilde{D}^3$$

The inclination of the Earth's orbit is zero by definition, and the argument of the ascending node is taken as zero. The mean heliocentric position and velocity of the Earth are obtained by converting the orbital elements to Cartesian coordinates. The mean orbital elements for Venus are (ref. 4, p. 113)

$$a_{\ominus} = 0.7233316\text{AU}$$

$$e_{\ominus} = 0.00682069 - 0.00004774T_e + 0.000000091T_e^2$$

$$\Omega_{\ominus} = 75^{\circ}46'46''.73 + 3239''.46T_e + 1''.476T_e^2$$

$$\omega_{\ominus} = 130^{\circ}9'49''.8 + 5068''.93T_e - 3''.515T_e^2 - \Omega_{\ominus}$$

$$i_{\ominus} = 3^{\circ}23'37''.07 + 3''.621T_e - 0''.0035T_e^2$$

$$M_{\ominus} = 212^{\circ}.603219 + 1^{\circ}.6021301540D + 0^{\circ}.000096400\tilde{D}^2$$

and for Mars (ref. 4, p. 113)

$$a_{\♁} = 1.5236915\text{AU}$$

$$e_{\♁} = 0.09331290 + 0.000092064T_e - 0.000000077T_e^2$$

$$\Omega_{\♁} = 48^{\circ}47'11''.19 + 2775''.57T_e - 0''.005T_e^2 - 0''.0192T_e^3$$

$$\omega_{\♁} = 334^{\circ}13'05''.53 + 6626''.73T_e + 0''.4675T_e^2 - 0''.0043T_e^3 - \Omega_{\♁}$$

$$i_{\mathcal{J}} = 1^{\circ}51'1''.20 - 2''.430T_e + 0''.0454T_e^2$$

$$M_{\mathcal{J}} = 319^{\circ}.529425 + 0^{\circ}.5240207666D + 0^{\circ}.000013553\tilde{D}^2 + 0^{\circ}.000000025\tilde{D}^3$$

Therefore, the mean heliocentric, ecliptic positions of the Earth and the planet (that is, $\vec{r}_{\odot\oplus}$ and $\vec{r}_{\odot P}$) can be obtained.

The vector from the planet to the Earth is

$$\vec{r}_{P\oplus} = \vec{r}_{\odot\oplus} - \vec{r}_{\odot P}$$

and the vector from the planet to the Sun is

$$\vec{r}_{P\odot} = -\vec{r}_{\odot P}$$

These vectors are rotated from the ecliptic to the Earth equatorial system by

$$\begin{bmatrix} X_{EE} \\ Y_{EE} \\ Z_{EE} \end{bmatrix} = \begin{bmatrix} 1 & 0 & 0 \\ 0 & \cos \epsilon & -\sin \epsilon \\ 0 & \sin \epsilon & \cos \epsilon \end{bmatrix} \begin{bmatrix} X_{EC} \\ Y_{EC} \\ Z_{EC} \end{bmatrix}$$

and to the planet equatorial system by the Euler rotation previously defined; that is,

$$\begin{bmatrix} X_{PE} \\ Y_{PE} \\ Z_{PE} \end{bmatrix} = \begin{bmatrix} R \\ \end{bmatrix} \begin{bmatrix} X_{EE} \\ Y_{EE} \\ Z_{EE} \end{bmatrix}$$

The unit vectors to the celestial bodies are therefore

$$\vec{E} = (E_{px}, E_{py}, E_{pz}) = \left(\frac{X_{PE}}{r_{PE}}, \frac{Y_{PE}}{r_{PE}}, \frac{Z_{PE}}{r_{PE}} \right)$$

where

$$r_{PE} = (X_{PE}^2 + Y_{PE}^2 + Z_{PE}^2)^{1/2}$$

The unit vector to the star Canopus in the planet equatorial system is found by first rotating the vector from the mean Earth equinox and equator of 1950 coordinate system

$$X_C = -0.060340592$$

$$Y_C = 0.60342839$$

$$Z_C = -0.79513092$$

to the mean Earth equinox and equator of date. This rotation is described in reference 4 (pp. 28 to 39). The updated position vector is then rotated to the planet equatorial system by

$$\vec{X}_{C,PE} = R\vec{X}_{C,EE}$$

The solution to the occultation problem is from reference 8 (p. 155) and the simplified geometry is shown in figure 7. The unit vector toward the body being occulted is defined by

$$\vec{E} = E_{px}\vec{i} + E_{py}\vec{j} + E_{pz}\vec{k}$$

which can be rotated to the PQW coordinate system; that is,

$$\vec{E} = E_p\vec{P} + E_q\vec{Q} + E_w\vec{W} \quad (5)$$

The radius vector to the spacecraft \vec{r} can be expressed in the PQW system by

$$\vec{r} = r \cos f\vec{P} + r \sin f\vec{Q} + 0\vec{W} \quad (6)$$

where

$$r = \frac{a(1 - e^2)}{1 + e \cos f} = \frac{l}{1 + e \cos f} \quad (7)$$

The geometric constraint can be obtained from the condition that upon entrance to or exit from the shadow, \vec{d} is parallel to \vec{E} ; therefore,

$$\vec{E} \cdot \vec{d} = -d$$

where

$$\vec{d} = \vec{r} - \vec{r}_s$$

and

$$d = \sqrt{r^2 - r_s^2}$$

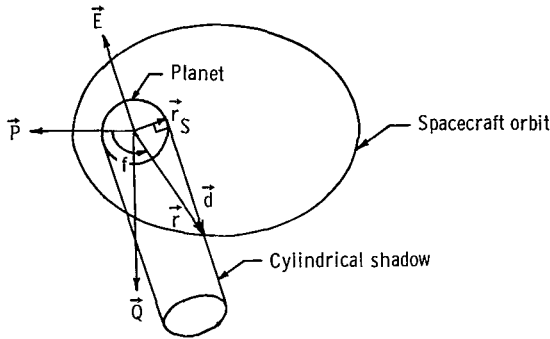

Figure 7.- Geometry of occultation.

Therefore,

$$\vec{E} \cdot (\vec{r} - \vec{r}_s) = -\sqrt{r^2 - r_s^2}$$

and since \vec{E} is perpendicular to \vec{r}_s ,

$$\vec{E} \cdot \vec{r} = -\sqrt{r^2 - r_s^2} \quad (8)$$

Expanding the dot product with equations (5) and (6) and eliminating r with equation (7) allows equation (8) to be expressed in terms of only the true anomaly; that is,

$$\frac{E_p l \cos f}{1 + e \cos f} + \frac{E_q l \sin f}{1 + e \cos f} = - \left[\frac{l^2}{(1 + e \cos f)^2} - r_s^2 \right]^{1/2}$$

which can be reduced to standard form as

$$C_0 \cos^4 f + C_1 \cos^3 f + C_2 \cos^2 f + C_3 \cos f + C_4 = 0 \quad (9)$$

where

$$\begin{aligned} C_0 &= \left(\frac{r_s}{l}\right)^4 e^4 - 2\left(\frac{r_s}{l}\right)^2 (E_q^2 - E_p^2) e^2 + (E_p^2 + E_q^2)^2 \\ C_1 &= 4\left(\frac{r_s}{l}\right)^4 e^3 - 4\left(\frac{r_s}{l}\right)^2 (E_q^2 - E_p^2) e \\ C_2 &= 6\left(\frac{r_s}{l}\right)^4 e^2 - 2\left(\frac{r_s}{l}\right)^2 (E_q^2 - E_p^2) - 2\left(\frac{r_s}{l}\right)^2 (1 - E_q^2) e^2 \\ &\quad + 2(E_q^2 - E_p^2)(1 - E_q^2) - 4E_p^2 E_q^2 \\ C_3 &= 4\left(\frac{r_s}{l}\right)^4 e - 4\left(\frac{r_s}{l}\right)^2 (1 - E_q^2) e \\ C_4 &= \left(\frac{r_s}{l}\right)^4 - 2\left(\frac{r_s}{l}\right)^2 (1 - E_q^2) + (1 - E_q^2)^2 \end{aligned}$$

All the real roots of equation (9) are extracted by Descartes technique (ref. 8, p. 430). The spurious roots are then rejected by

$$|\vec{r} \times \vec{E}| = r_s$$

$$\vec{r} \cdot \vec{E} < 0$$

It can be shown that the spacecraft enters the shadow at f_1 provided that

$$2r_s^2(1 + e \cos f_1)(-e \sin f_1) + 2l^2(E_p \cos f_1 + E_q \sin f_1)(-E_p \sin f_1 + E_q \cos f_1) > 0$$

where f_1 is a solution of equation (9). The exit from the shadow is at f_2 . Once f_1 and f_2 have been determined, pertinent parameters such as the length of time in the shadow can be computed.

Vertical Photography at a Specific Lighting Angle

The positions in the orbit of the satellite about the planet that correspond to desirable lighting conditions on the surface for vertical photography are of interest in mission

analysis. These positions along with the orbital elements lead to the definition of the surface which can be photographed.

The lighting angle ψ is the angle between the planet-Sun vector and the planet-satellite radius vector. When the lighting angle is 90° , the satellite is directly over the terminator. The unit vector from the planet toward the Sun is rotated to the PQW coordinate system by

$$\begin{bmatrix} E_p \\ E_q \\ E_w \end{bmatrix} = \begin{bmatrix} \text{RPQW} \end{bmatrix} \begin{bmatrix} E_{px} \\ E_{py} \\ E_{pz} \end{bmatrix}$$

where RPQW is the rotation matrix from the planet equatorial to the PQW system and is defined by

$$\text{RPQW} = \begin{bmatrix} \cos \omega \cos \Omega & \cos \omega \sin \Omega & \sin \omega \sin i \\ -\sin \omega \cos i \sin \Omega & +\sin \omega \cos i \cos \Omega & \\ -\sin \omega \cos \Omega & -\sin \omega \sin \Omega & \cos \omega \sin i \\ -\cos \omega \cos i \sin \Omega & +\cos \Omega \cos \omega \cos i & \\ \sin \Omega \sin i & -\sin i \cos \Omega & \cos i \end{bmatrix}$$

The unit vector from the planet toward the spacecraft in the PQW coordinate system is given by

$$\vec{r} = \cos f \vec{P} + \sin f \vec{Q} + 0 \vec{W}$$

Since ψ is the angle between the Sun vector and the radius vector

$$\vec{E} \cdot \vec{r} = \cos \psi$$

$$|\vec{E} \times \vec{r}| = \sin \psi$$

From the dot product

$$E_p \cos f + E_q \sin f = \cos \psi$$

or

$$\cos f = \frac{\cos \psi - E_q \sin f}{E_p} \quad (10)$$

From the cross product

$$E_w^2 \sin^2 f + E_w^2 \cos^2 f + (E_q \cos f - E_p \sin f)^2 = \sin^2 \psi \quad (11)$$

Using equation (10) to eliminate the $\cos f$ in equation (11) and putting in standard form gives

$$C_0 \sin f + C_1 \sin f + C_2 = 0 \quad (12)$$

where

$$C_0 = \frac{E_q^4}{E_p^2} + 2E_q^2 + E_p^2$$

$$C_1 = \frac{-2E_q^3}{E_p^2} \cos \psi - 2E_q \cos \psi$$

$$C_2 = E_w^2 + \frac{E_q^2}{E_p^2} \cos^2 \psi - \sin^2 \psi$$

The quadratic formula is used to obtain the sines of f_1 and f_2 , and equation (10) is used to obtain the corresponding cosines. Therefore,

$$f_{1,2} = \tan^{-1} \left(\frac{\sin f_{1,2}}{\cos f_{1,2}} \right)$$

There are two true anomalies that correspond to a given lighting condition. It is very important to determine whether the satellite is entering the desirable lighting conditions or leaving these conditions. Differentiating equation (10) with respect to time yields

$$\dot{\psi} = \dot{f} \left(\frac{E_q \cos f - E_p \sin f}{-\sin \psi} \right)$$

and since $\dot{f} \geq 0$,

$$\text{sign}(\dot{\psi}) = \text{sign} \left(\frac{E_q \cos f - E_p \sin f}{-\sin \psi} \right)$$

If $\text{sign}(\dot{\psi})$ is positive, the lighting angle is increasing; if $\text{sign}(\dot{\psi})$ is negative, the lighting angle is decreasing. Distinction between ascending and descending motion at the true anomalies in question is made by the following:

Ascending motion:

$$-90^\circ < \omega + f < 90^\circ$$

Descending motion:

$$90^\circ < \omega + f < 270^\circ$$

RESULTS AND DISCUSSION

The computer program has three distinct advantages. The use of Keplerian mechanics and analytic solutions to the occultation and imagery problems has resulted in an extremely fast program. The use of mean orbital elements to generate the ephemerides of the planets is considered to be an advantage in that the program is self-contained and does not require the use of ephemeris tapes. Possibly, the major advantage of the program is the modular form in which it is written. This form allows the user to insert additional calculations into the program with a minimum of effort. The subroutines (appendix B) have been written in as general a form as possible and can be easily adapted to various orbital-mechanics problems. The modular form in which VAMOOS was written resulted in a field length (storage requirement) of 40 000g.

Sample plots which have been found useful in design studies for a Mars mission are presented in figures 8, 9, and 10. The orbital inclinations which result in Sun, Earth, or Canopus occultations during the first revolution of the satellite about the planet can be seen in figure 8. In addition, the duration of the occultation period is given. This type of plot has been found useful in selecting an orbital inclination that insures visibility of the satellite from Earth and provides adequate sunlight for the satellite. The computing

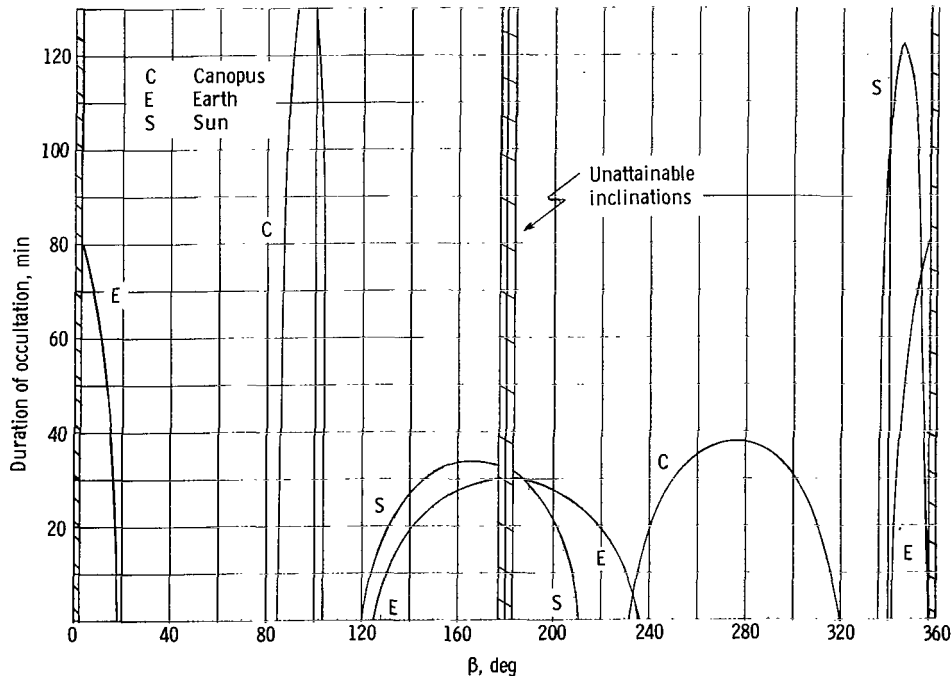

Figure 8.- Sun, Earth, and Canopus occultation durations during first satellite revolution about Mars.

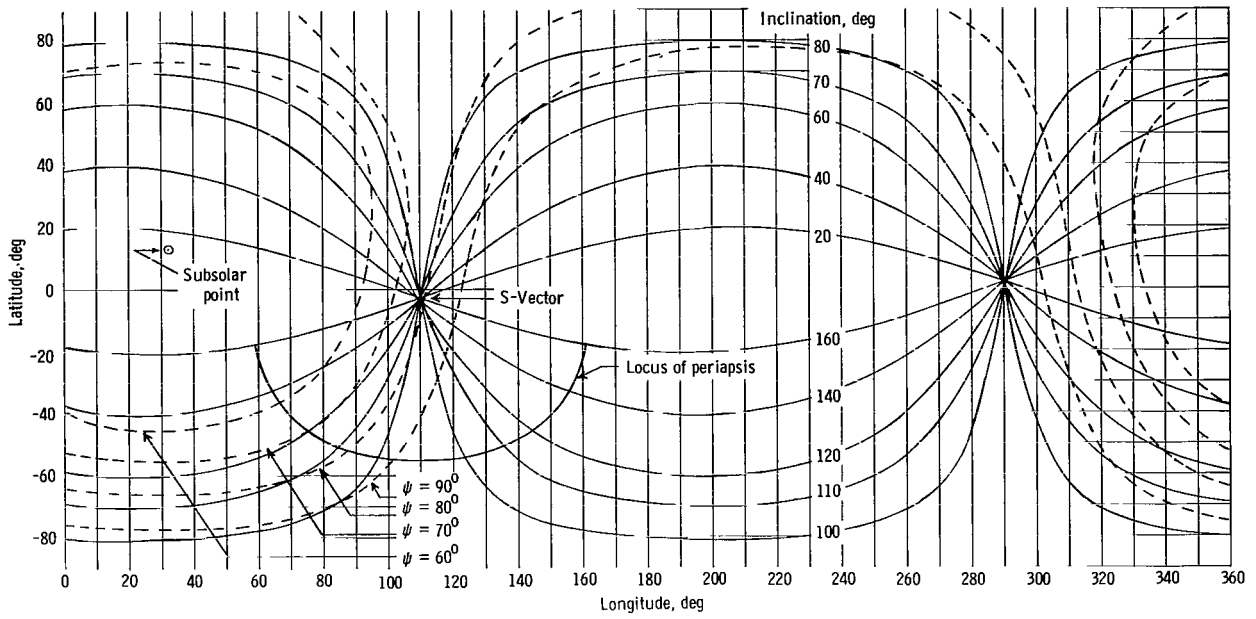

Figure 9.- Ground tracks and lighting angles for satellite orbits about Mars.

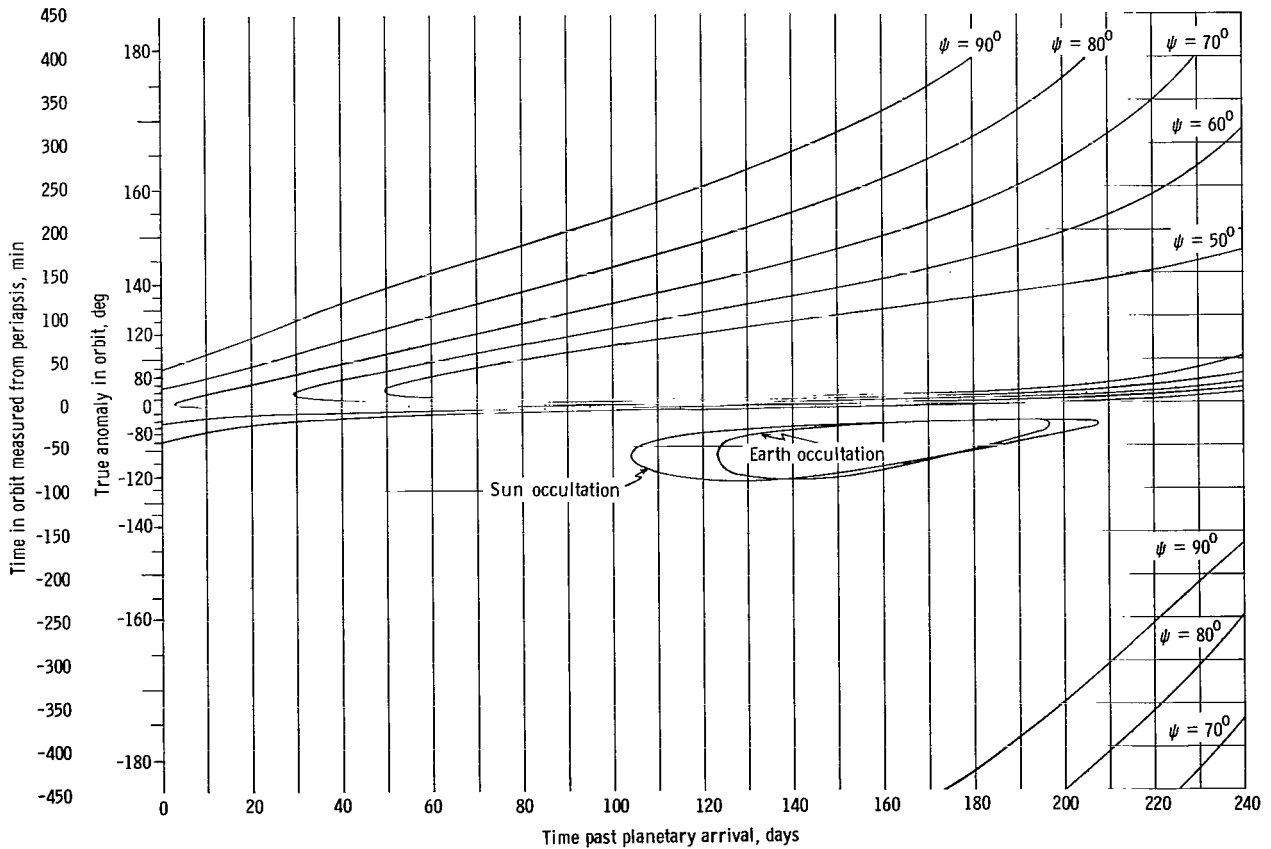

Figure 10.- Mission sequence of events for a satellite orbit about Mars.

time on the digital computer for the data presented in figure 8 was 0.16 second. Ground-track and lighting-angle plots (fig. 9) have been found useful in examining the imagery requirements for an orbital planetary mission. For a given orbital inclination the sequence of events during many satellite revolutions can be generated with the program. (See fig. 10.)

CONCLUDING REMARKS

A program for the calculation of mission design data for either Mars or Venus has been developed. The planetocentric elliptical orbit about the planet is examined to determine the times at which the satellite enters and exits the shadows of the Sun, Earth, and Canopus. The photographic coverage of the surface of the planet is also determined. Because of the speed and simplicity of the calculations, VAMOOS has proved to be a useful and flexible tool for mission design.

Langley Research Center,
National Aeronautics and Space Administration,
Langley Station, Hampton, Va., December 13, 1968,
194-82-01-05-23.

APPENDIX A

PROGRAM DESCRIPTION

The VAMOOS program has been written entirely in FORTRAN IV computer language for the Control Data 6600 digital computer and contains a main program and 27 subroutines. The modular form in which the program was written resulted in a field length (storage requirement) of 40 000g. Very few calculations are performed in the main program since its primary purpose is one of administration. The input data are read into the main program and the appropriate subroutines are used to perform the desired computations. The angle β (fig. 1) can be incremented from 0° to 360° in whole degrees at the discretion of the user. An additional program option allows for the range of β to be investigated at a future date by stepping the planet in time within its orbit about the Sun. This option permits the time after arrival to be incremented over any time period with printout as frequently as desired. The second zonal harmonic J_{20} can be incorporated in these calculations to perturb ω and Ω of the satellite orbit by the appropriate input if such is desired. All these options are controlled by the main program which is outlined in the flow diagram. The letters in parentheses correspond to the subroutine that performs the stated calculation. A brief statement of the purpose of each subroutine contained in the program follows:

JULCAL	Converts Julian data to calendar data
REQVEQ	Rotates a vector from the mean Earth equinox and equator of date coordinate system to the mean Venus equinox and equator of date coordinate system
REQMEQ	Rotates a vector from the mean Earth equinox and equator of date coordinate system to the mean Mars equinox and equator of date coordinate system
REQPEQ	Rotates a vector from the mean Earth equinox and equator of date coordinate system to the mean planet equinox and equator of date coordinate system
RECEQ	Rotates a vector from the mean equinox and ecliptic of date coordinate system to the mean Earth equinox and equator of date coordinate system
RXYZPQW	Rotates a vector from the XYZ to the PQW coordinate system
RPQWXYZ	Rotates a vector from the PQW to the XYZ coordinate system

APPENDIX A

EEARTH	Calculates the mean heliocentric position and velocity of Earth
EVENUS	Calculates the mean heliocentric position and velocity of Venus
EMARS	Calculates the mean heliocentric position and velocity of Mars
SUN	Calculates the positions in orbit which correspond to various lighting angles and writes output data
SUNBAND	Calculates the two positions in orbit which correspond to a given lighting angle
OCCULT	Calculates the entrance and exit true anomalies of occultation
CONCAR	Converts conic elements to Cartesian coordinates
CARSPH	Converts Cartesian to spherical coordinates
TCONIC	Calculates the time from periapsis passage for a given true anomaly
TINVS	Converts mean anomaly to eccentric and true anomaly
QADRAT	Solves the equation $AX^2 + BX + C = 0$ for the real roots
CUBIC	Solves the equation $AX^3 + BX^2 + CX + D = 0$ for the real roots
QARTIC	Solves the equation $AX^4 + BX^3 + CX^2 + DX + E = 0$ for the real roots
CROSS	Calculates the vector cross product
DOT	Calculates the angle between two vectors
ORBIT	Calculates Keplerian orbital elements for a periapsis to periapsis deboost
PRECES	Transforms mean Earth equinox and equator coordinates from one epoch to another epoch
LATLNG	Converts a Cartesian position to latitude and longitude

APPENDIX A

EULER	Performs an Euler rotation
VECTOR	Calculates the position of the Sun, Earth, and Canopus in the planetocentric, planet equator, coordinate system and writes output data

APPENDIX A

FLOW DIAGRAM FOR MAIN PROGRAM

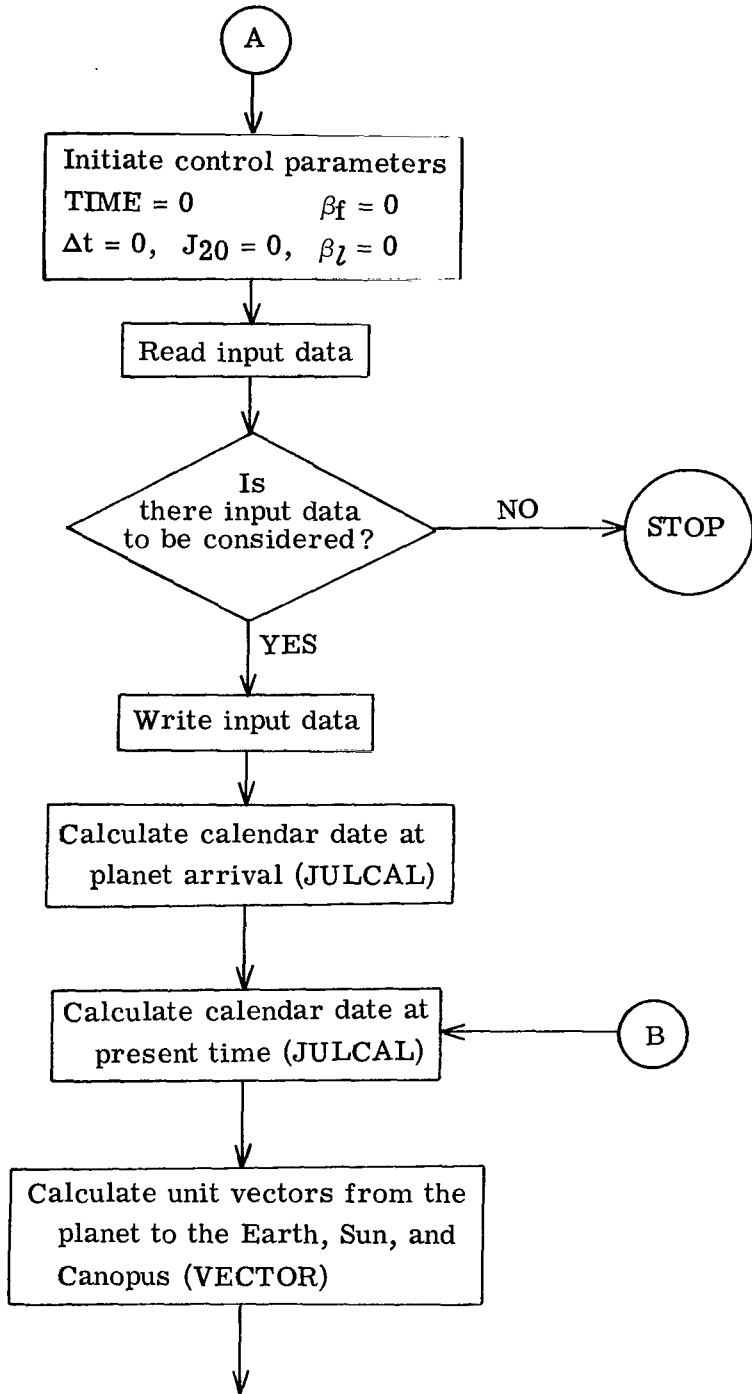

APPENDIX A

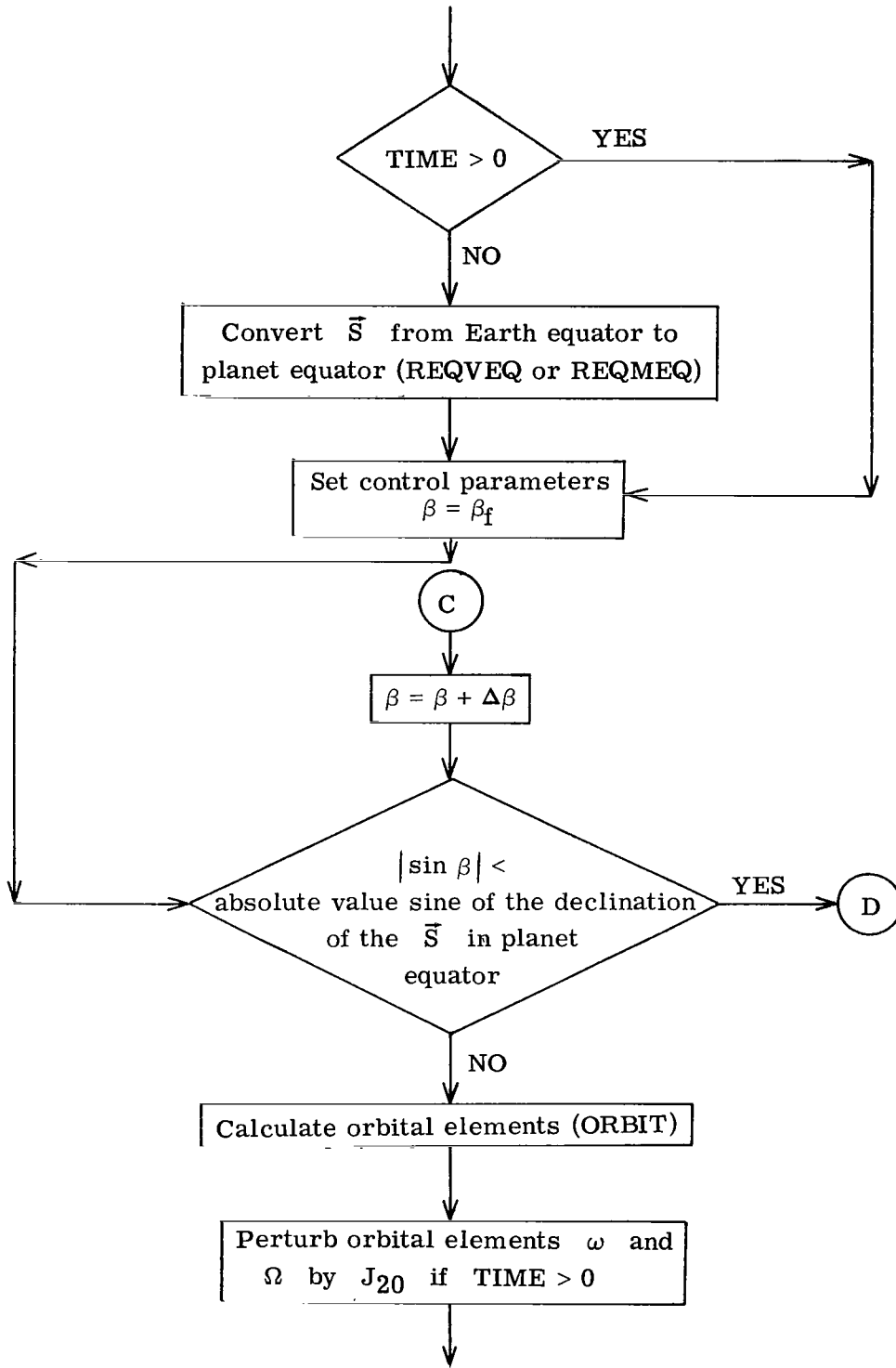

APPENDIX A

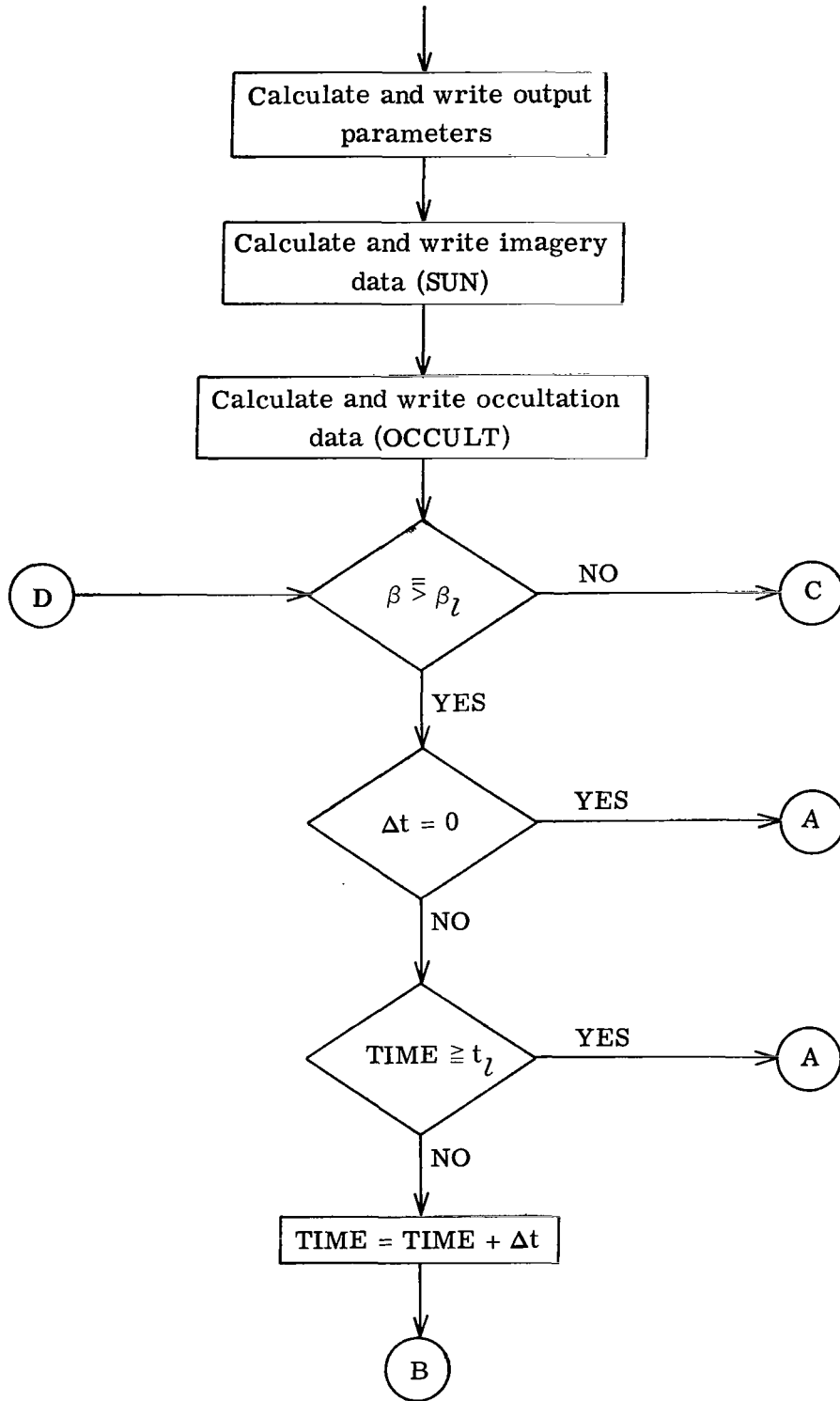

APPENDIX B

PROGRAM LISTING

A complete FORTRAN IV listing of the program VAMOOS is contained herein. The purpose of each subroutine is stated in the listing along with a brief definition of the input and output parameters. If additional subroutines are required for the computations contained in a specific subroutine, this fact is also designated.

```
C
C   VAMCOS PROGRAM - VENUS AND MARS ORBITAL OCCULTATION SIMULATOR
C   PROGRAMMED FOR THE CDC 6600
C
C   THIS PROGRAM CALLS SUBROUTINES JULCAL, REQVEQ, REQMEQ, REQPEQ, RECEQ,
C   RXYZPCW, RPQWXYZ, EEARTH, EVENUS, EMARS, SUN, SUNBAND, OCCULT, CONCAR,
C   CARSPF, TCCNIC, TINVS, QADRAT, CUBIC, QARTIC, CROSS, DOT, ORBIT,
C   PRECES, LATLNG, EULER, VECTOR
C
C   DIMENSION G(6),E(6),RPQW(3,3),SUNB(6)
C   REAL JD
C   NAMELIST/CASE/JC,SVDECE,SVRAE,VINF,HA,HP,BFRST,BLAST,BSTEP,TLAST,T
1STEP,XJ20,IPOCY,SLN1,SUN2,SUN3,SUN4,SUN5,SUN6
C   ANGLE(X)=AMCD(X,360.)+180.-SIGN(180.,X)
C
C   RD=57.2957795130823
C   DR=C.01745329251994
C   PI=3.14159265358979
C   UVENUS=324853.4
C   RVENUS=6085.
C   UMARS=42977.8
C   RMARS=3395.
C
C   600 TLAST=C.
C   TSTEP=C.
C   BFRST=C.
C   BSTEP=C.
C   BLAST=C.
C   TIME=C.
C   XJ20=C.
C   SVDECE=0.
C   SVRAE=0.
C   SUN1=C.
C   SUN2=C.
C   SUN3=C.
C   SUN4=C.
C   SUN5=C.
C   SUN6=C.
C
C   READ(5,CASE)
C
C   WRITE(6,CASE)
C   IF(ECF,5) 800,1
C
```

APPENDIX B

```

1  CCNTINUE
   SUNB(1)=SUN1
   SLNB(2)=SUN2
   SLNB(3)=SUN3
   SUNB(4)=SUN4
   SLNB(5)=SUN5
   SUNB(6)=SLN6
C
   IF(IBODY.EQ.2) GO TO 20
   IF(IBODY.EQ.4) GO TO 21
C
20  U=LVENLS
    RS=RVENLS
    GO TO 22
21  U=LVMARS
    RS=RMARS
C
22  CONTINUE
    WJC=FLOAT(IFIX(JD))
    FJD=JD-WJD
    IF(FJD.EQ..5) FJD=FJD+0.00001
    CALL JULCAL(G,WJD,FJD,C)
    IYA=IFIX(G(1))
    IMA=IFIX(G(2))
    IDA=IFIX(G(3))
C
2  CALL JULCAL(B,WJD,FJD,C)
    IYB=IFIX(B(1))
    IMB=IFIX(B(2))
    ICB=IFIX(B(3))
C
    WRITE(6,101) JD,IYE,IME,ICB,IYA,IMA,IDA
C
    CALL VECTOR(JD,DECS,RAS,DECE,RAE,DECC,RAC,SX,SY,SZ,EX,EY,EZ,CX,CY,
1CZ,IBJDY)
C
    IF(TIME.GT..01) GO TO 7
    IF(IBODY.EQ.2) GO TO 3
    IF(IBODY.EQ.4) GO TO 4
C
3  CALL REQVEQ(JD,COS(SVDECE*DR)*COS(SVRAE*DR),COS(SVDECE*DR)*SIN(SV
1AE*DR),SIN(SVDECE*DR),XSVP,YSVP,ZSVP,SVDECP,SVRAP)
    GO TO 5
4  CALL REQMEQ(JD,COS(SVDECE*DR)*COS(SVRAE*DR),COS(SVDECE*DR)*SIN(SV
1AE*DR),SIN(SVDECE*DR),XSVP,YSVP,ZSVP,SVDECP,SVRAP)
C
5  IF(BSTEP.LT..001) GO TO 6
    IB1=IFIX(BFRST)
    IB2=IFIX(BLAST)
    IB3=IFIX(BSTEP)
    GO TO 7
6  IB1=1000
    IB2=1000
    IB3=1000
C
7  DC 11 I=IB1,IB2,IB3
C

```

APPENDIX B

```

BETA=FLOAT(I)
IF(I.EQ.100) BETA=BFRST
IF(ABS(SIN(BETA*DR)).LT.ABS(SIN(SVDECP*DR))) GO TO 11
C
CALL CRBIT(SVDECP,SVRAP,VINF,HA,HP,BETA,A,E,XI,W,O,PDEC,PRA,U,RS)
IF(TIME.LT..01) GO TO 8
XN=SQRT(U/A**3)
ODOT=-3./2.*XJ20*XN*(RS/A)**2/(1.-E**2)*CCS(XI*DR)
WDOT=3.*XJ20*XN*(RS/A)**2/(1.-E**2)*(1.-5./4.*SIN(XI*DR)**2)
W=h+(WDOT*TIME*24.*3600.)*RD
Q=C+(QDOT*TIME*24.*3600.)*RC
PDEC=ASIN(SIN(W*DR)*SIN(XI*DR))*RD
SSDEL=TAN(PDEC*DR)/TAN(XI*DR)
CSDEL=SSDEL/TAN(W*DR)/COS(XI*DR)
SDEL=ATAN2(SSDEL,CSDEL)*RD
PRA=ANGLE(O+SDEL)
8 CONTINUE
C
IF(IBCXY.EQ.2) WRITE(6,102) BETA,TIME
IF(IBCXY.EQ.4) WRITE(6,103) BETA,TIME
C
CALL RXYZPCW(O.,C.,O.,XI,h,O,RPQW,VP,VQ,VW)
CALL DOT(+RPQW(2,1),+RPQW(2,2),+RPQW(2,3),SX,SY,SZ,THRUST)
CALL DLT(COS(SVDECP*DR)*CCS(SVRAP*DR),COS(SVDECP*DR)*SIN(SVRAP*DR)
1,SIN(SVDECP*DR),SX,SY,SZ,ZAP)
SVP=ACOS(U/(U+(RS+P)*VINF**2))*RD

VPE=SQRT(U*(RS+P)/A/(RS+HP))
VPH=SQRT(VINF**2+2.*U/(RS+HP))
DELV=VPH-VPE
VAE=VPE*(1.-E)/(1.+E)
PERIOD=2.*PI*SQRT(A**3/U)/3600.
C
WRITE(6,104) SVDECP,SVRAP,VINF,SVDECP,SVRAP,HA,HP,JD,PDEC,PRA,((RP
1QW(J,K),K=1,3),J=1,3),THRUST,A,E,XI,W,O,DECS,RAS,DECE,RAE,SX,SY,SZ
2,EX,EY,EZ,PERIOD,CX,CY,CZ,ZAP,SVP,VPE,VAE,VPH,DELV,XJ20
C
IF(SUN1.LT..01) GO TO 12
CALL SUN(SX,SY,SZ,SLNB,A,E,XI,W,O,RPQW,U,RS,1)
C
12 CALL OCCULT(A,E,XI,h,O,U,RS,SX,SY,SZ,TOCC,T1,ALT1,F1,DEC1,RA1,T2,A
1LT2,F2,DEC2,RA2,KK)
WRITE(6,105) TOCC,T1,F1,ALT1,DEC1,RA1,T2,F2,ALT2,DEC2,RA2
CALL OCCULT(A,E,XI,W,O,U,RS,EX,EY,EZ,TOCC,T1,ALT1,F1,DEC1,RA1,T2,A
1LT2,F2,DEC2,RA2,KK)
WRITE(6,106) TOCC,T1,F1,ALT1,DEC1,RA1,T2,F2,ALT2,DEC2,RA2
CALL OCCULT(A,E,XI,W,O,U,RS,CX,CY,CZ,TOCC,T1,ALT1,F1,DEC1,RA1,T2,A
1LT2,F2,DEC2,RA2,KK)
WRITE(6,107) TOCC,T1,F1,ALT1,DEC1,RA1,T2,F2,ALT2,DEC2,RA2
C
11 CONTINUE
C
IF(TSTEP.LT..001) GO TO 600
IF(TIME.GE.TLAST) GO TO 600
TIME=TIME+TSTEP
WJD=WJD+FLOAT(IFIX(TSTEP))
FJD=FJD+AMGD(TSTEP,1.)
JD=WJD+FJD
GO TO 2

```

APPENDIX B

```

C
101 FORMAT(1H1          ///17H JULIAN DATE          F2C.1//22X,22HYEAR          MC
      INT          DAY//22H CALENDAR DATE          ,I4,5X,I3,7X,I3//22H ARRIVAL
      2 DATE          ,I4,5X,I3,7X,I3)
102 FORMAT(*1*///14X,* BETA          =*,F9.4,4X,*(VENUS EQUATOR,
      1VENUS EQUINCX)*/14X,* TIME PAST ARRIVAL = *,F8.1,* DAYS*)
103 FORMAT(*1*///14X,* BETA          =*,F9.4,4X,*(MARS EQUATOR, M
      1ARS EQUINOX)*/14X,* TIME PAST ARRIVAL = *,F8.1,* DAYS*)
104 FORMAT(1HC/,9F SVDECE=E16.8,10H SVRAE =E16.8,1CH VINF =E16.8
      1,10H SVDECP=E16.8/9H SVRAP =E16.8,10H FA =E16.8,10H HP
      2 =E16.8,1CH JD =E16.8/9H PLAT =E16.8,10H PLONG=E16.8,10
      3H PX =E16.8,10H PY =E16.8/9H PZ =E16.8,10H CX =
      4E16.8,10H QY =E16.8,10H QZ =E16.8/9H WX =E16.8,10H
      5 WY =E16.8,1CH WZ =E16.8,10H VELSUN=E16.8/9H SMA =E16
      6.8,10H ECC =E16.8,10H INC =E16.8,10H ARGPER=E16.8/9H AR
      7GNCD=E16.8,10H DECSJN=E16.8,10H RASUN =E16.8,10H DECETH=E16.
      88/9F RAETH =E16.8,10H XSUN =E16.8,10H YSUN =E16.8,10H ZSU
      9N =E16.8/9F XEARTH=E16.8,10H YEARTH=E16.8,10H ZEARTH=E16.8,1
      10H PERIOD=E16.8/9F XCANPS=E16.8,10H YCANPS=E16.8,10H ZCANPS
      2=E16.8,1CH ZAP =E16.8/9H SVP =E16.8,10H VPE =E16.8,10H
      3 VAE =E16.8,10H VPH =E16.8/9H DELV =E16.8,10H XJ20 =E1
      46.8)
105 FORMAT(22HC SUN OCCULTATION TIME,15X,F11.2/23H ENTER SUN OCCULTATI
      1ON,14X,5F11.2/22H EXIT SUN OCCULTATION,15X,5F11.2)
106 FORMAT(24HC EARTH OCCULTATION TIME,13X,F11.2/25H ENTER EARTH OCCU
      1LTATION,12X,5F11.2/24H EXIT EARTH OCCULTATION,13X,5F11.2)
107 FORMAT(26HC CANOPUS OCCULTATION TIME,11X,F11.2/27H ENTER CANOPUS
      1OCCULTATION,10X,5F11.2/26H EXIT CANOPUS OCCULTATION,11X,5F11.2)

```

```

C
800 STOP
      END
      SLBROUTINE JULCAL(X,WDI,FDI,IND)
C
C      THIS SUBROUTINE CONVERTS A GIVEN JULIAN DATE OR THE NUMBER OF
C      WHOLE AND FRACTIONAL DAYS SINCE JANUARY 1, 1950, 0 HRS., TO THE
C      CORRESPONDING CALENDAR DATE.
C
C      WDI - INTEGRAL PART OF JULIAN DATE OR WHOLE NUMBER OF DAYS SINCE
C      JANUARY 1, 1950, 0 HRS.
C      FDI - FRACTIONAL PART OF JULIAN DATE OR FRACTIONAL NUMBER OF DAYS
C      SINCE JANUARY 1, 1950, 0 HRS.
C      IND - CONTROL INTEGER. 0 IMPLIES JULIAN DATE, 1 IMPLIES DAYS
C      X(1-6) - CALENDAR DATE (YEAR,MONTH,DAY, HOUR,MINUTE,SECOND )
C
      DIMENSION X(6),A(12),W(12)
      WD=WDI
      FD=FDI
      IF(IND)1,1,5
      1 IF(FD-.5)2,2,3
      2 FD=FD+.5
      WD=WD-1.
      GO TO 4
      3 FD=FD-.5
      4 WD=WD-2433282.
      5 WD=WD+1.
      DY=365.
      Z=2.
      N=C
      Q=4.
      6 WD=WD-DY

```

APPENDIX B

```

      IF (WD) 10, 10, 7
7  N=N+1
   Z=Z+1.
   CK=Q-Z
   IF(CK)9,9,8
8  DY=365.
   FC=28.
   GO TO 6
9  DY=366.
   Q=Q+4.
   FC=29.
   GO TO 6
10 WD=WD+DY

   DO 11 I=1,12
11 A(I)=C.
   C1=31.
   C2=30.
   DO 13 I=1,12
   A(I)=1.
   CA=FC*A(2)+C1*(A(1)+A(3)+A(5)+A(7)+A(8)+A(10)+A(12))+C2*(A(4)+
1  A(6)+A(9)+A(11))
   W(I)=WD-CA
   IF(W(I))12,12,13
12 IF(I-1)15,15,16
15 MON=1
   GO TO 14
16 MON=I-1
   WD=W(MCN)
   MCN=MCN+1
   GO TO 14
13 CONTINUE
14 N=N+50
   X(1)=N
   X(2)=MCN
   X(3)=WD
   FH=FD*24.
   N=FH
   X(4)=N
   FM=(FH-X(4))*60.
   N=FM
   X(5)=N
   X(6)=(FM-X(5))*60.
   RETURN
   END

```

SLEROUTINE REQVEQ(JD,XEC,YEQ,ZEQ,XVEQ,YVEQ,ZVEQ,DECVEQ,RAVEQ)

C
C THIS SUBROUTINE ROTATES A VECTOR FROM THE MEAN EARTH EQUATOR-
C EQUINOX TO THE MEAN VENUS EQUATOR-EQUINOX COORDINATE SYSTEM. THIS
C ROUTINE CALLS SUBROUTINES REQPEQ AND LATLNG.
C

C JD - JULIAN DATE AT TIME OF INTEREST.
C XEC,YEQ,ZEQ - VECTOR IN THE EARTH EQUATORIAL SYSTEM
C XVEQ,YVEQ,ZVEQ - VECTOR IN THE VENUS EQUATORIAL SYSTEM
C DECVEQ,RAVEQ - DECLINATION AND RIGHT ASCENSION OF THE VECTOR IN
C THE VENUS EQUATORIAL SYSTEM
C

REAL JD

APPENDIX B

```

C
C   TE=(JD-2415020.)/36525.
C
C   ALPHAO=272.75
C   GAMMAO=71.50
C   OMEGA=75.779648+C.899850*TE+0.000411*TE**2
C   XI=3.393630+0.001005*TE-C.970E-6*TE**2
C
C   CALL REQPEQ(JD,ALPHAO,GAMMAO,OMEGA,XI,XEQ,YEQ,ZEQ,XVEQ,YVEQ,ZVEQ)
C   CALL LATLNG(XVEQ,YVEQ,ZVEQ,DECVEQ,RAVEQ)
C
C   RETURN
C   END

```

```

C
C   SUBROUTINE RECMEQ(JD,XEQ,YEQ,ZEQ,XMEQ,YMEQ,ZMEQ,DECMEQ,RAMEQ)
C
C   THIS SUBROUTINE ROTATES A VECTOR FROM THE MEAN EARTH EQUATOR-
C   EQUINOX TO THE MEAN MARS EQUATOR-EQUINOX COORDINATE SYSTEM. THIS
C   ROUTINE CALLS SUBROUTINES REQPEQ AND LATLNG.
C
C   JD - JULIAN DATE AT TIME OF INTEREST
C   XEQ,YEQ,ZEQ - VECTOR IN THE EARTH EQUATORIAL SYSTEM
C   XMEQ,YMEQ,ZMEQ - VECTOR IN THE MARS EQUATORIAL SYSTEM
C   DECMEQ,RAMEQ - DECLINATION AND RIGHT ASCENSION OF THE VECTOR IN
C   THE MARS EQUATORIAL SYSTEM
C
C   REAL JD
C
C   TE=(JD-2415020.)/36525.
C   TAU=AMCD(TE*100.,1.)
C   TP=TE*100.-TAU-50.
C
C   ALPHAO=317.793416667+0.6520833E-2*TP-0.001013*TAU
C   GAMMAO=54.65750000+C.0035*TP-0.000631*TAU
C   OMEGA=48.78644167+C.77099167*TE-0.13888889E-5*TE**2
C   XI=1.850333333-C.675E-3*TE+0.12611111E-4*TE**2
C
C   CALL REQPEQ(JD,ALPHAO,GAMMAO,OMEGA,XI,XEQ,YEQ,ZEQ,XMEQ,YMEQ,ZMEQ)
C   CALL LATLNG(XMEQ,YMEQ,ZMEQ,DECMEQ,RAMEQ)
C
C   RETURN
C   END

```

```

C
C   SUBROUTINE RECPEQ(JD,ALPHAO,GAMMAO,OMEGA,XI,XEQ,YEQ,ZEQ,XPEQ,YPEQ,
C   1ZPEQ)
C
C   THIS SUBROUTINE ROTATES A VECTOR FROM MEAN EARTH EQUATOR-EQUINOX
C   TO PLANET EQUATOR-EQUINOX COORDINATE SYSTEM. THIS ROUTINE CALLS
C   SUBROUTINE EULER.
C

```

APPENDIX B

```

C      JD - JULIAN DATE AT TIME OF INTEREST
C      ALPHA0,GAMMA0 - RIGHT ASCENSION AND DECLINATION OF THE PLANETS
C      AXIS OF ROTATION EXPRESSED IN THE EARTH EQUATORIAL
C      COORDINATE SYSTEM
C      OMEGA,XI - LONGITUDE OF THE ASCENDING NODE AND INCLINATION OF THE
C      PLANETS ORBITAL PLANE REFERENCED TO THE ECLIPTIC AND
C      VERNAL EQUINOX
C      XEC,YEC,ZEC - COMPONENTS OF THE VECTOR IN THE EARTH EQUATORIAL
C      COORDINATE SYSTEM
C      XPEQ,YPEQ,ZPEQ - COMPONENTS OF THE VECTOR IN THE PLANET EQUATORIAL
C      COORDINATE SYSTEM

      REAL JD
      DIMENSION RPQW(3,3)
      DR=0.017453292519943
      RC=57.2957795130823
      TE=(JD-2415020.)/36525.
      E=23.45229444-0.130125E-1*TE-0.16388889E-5*TE**2+0.50277778E-6*TE*
1*3

C      CE=COS(E*DR)
      SE=SIN(E*DR)
      CAL=COS(ALPHA0*DR)
      SAL=SIN(ALPHA0*DR)
      CGM=COS(GAMMA0*DR)
      SGM=SIN(GAMMA0*DR)
      CCM=CCS(OMEGA*DR)
      SOM=SIN(OMEGA*DR)

C      CZP=CE*SCM*CAL-CCM*SAL
      SZP=SQRT(1.-CZP*CZP)
      ZP=ATAN2(SZP,CZP)*RC
      SXP=SE*CAL/SZP
      CXP=(-CE*CCM*CAL-SCM*SAL)/SZP
      XP=ATAN2(SXP,CXP)*RC
      SYF=SE*SOM/SZP
      CYP=(CE*SCM*SAL+CCM*CAL)/SZP
      YP=ATAN2(SYF,CYP)*RC

C      CI=CCS((XP-XI)*DR)*SIN((YP-GAMMA0)*DR)+SIN((XP-XI)*DR)*COS((YP-GAM
1MA0)*DR)*CZP
      SI=SQRT(1.-CI*CI)

C      SWP=SZP*SIN((XP-XI)*DR)/SI
      CWF=(-CCS((XP-XI)*DR)*CCS((YP-GAMMA0)*DR)+SIN((XP-XI)*DR)*SIN((YP-
1GAMMA0)*DR)*CZP)/SI
      WP=ATAN2(SWP,CWF)*RC

C      CALL EULER( )EC,YEC,ZEQ,XPEQ,YPEQ,ZPEQ,90.+ALPHA0,WP+180.,90.-GAMMA
10,0.,0.,0.,0.,0.,0.,1,0)

C      RETURN
      END

```

APPENDIX B

SUBROUTINE RECEQ(JC,XEC,YEC,ZEC,XEQ,YEQ,ZEQ)

THIS SUBROUTINE ROTATES A VECTOR FROM THE MEAN EQUINOX AND ECLIPTIC OF DATE TO THE MEAN EARTH EQUINOX AND EQUATOR OF DATE COORDINATE SYSTEM

JC - JULIAN DATE

XEC,YEC,ZEC - COMPONENTS OF THE VECTOR IN THE MEAN EQUINOX AND ECLIPTIC OF DATE COORDINATE SYSTEM

XEQ,YEQ,ZEQ - COMPONENTS OF THE VECTOR IN THE MEAN EARTH EQUINOX AND EQUATOR OF DATE COORDINATE SYSTEM

REAL JD

DR=.C17453292519943

TE=(JD-2415020.)/36525.

XIE=23.452294-0.0130125*TE-0.00000164*TE**2+0.000000503*TE**3

C=COS(XIE*DR)

S=SIN(XIE*DR)

XEQ=XEC

YEQ=YEC*C-ZEC*S

ZEQ=YEC*S+ZEC*C

RETURN

END

SUBROUTINE RXYZPQW(VX,VY,VZ,XI,W,O,RPQW,VP,VQ,VW)

THIS SUBROUTINE ROTATES A VECTOR FROM THE XYZ TO THE PQW COORDINATE SYSTEM

VX,VY,VZ - COMPONENTS OF THE VECTOR IN THE XYZ SYSTEM

XI,W,O - INCLINATION, ARGUMENT OF PERIAPSIS, AND LONGITUDE OF THE ASCENDING NODE

RPQW - ROTATIONAL MATRIX FROM THE XYZ TO THE PQW SYSTEM

VP,VQ,VW - COMPONENTS OF THE VECTOR IN THE PQW SYSTEM

DIMENSION RPQW(3,3)

DR=.C17453292519943

CW=COS(W*DR)

SW=SIN(W*DR)

CO=COS(O*DR)

SO=SIN(O*DR)

CXI=COS(XI*DR)

SXI=SIN(XI*DR)

RPQW(1,1)=CW*CO-SW*SO*CXI

RPQW(1,2)=CW*SO+SW*CO*CXI

RPQW(1,3)=SW*SXI

RPQW(2,1)=-SW*CO-CW*SO*CXI

RPQW(2,2)=-SW*SO+CW*CO*CXI

RPQW(2,3)=CW*SXI

RPQW(3,1)=SO*SXI

RPQW(3,2)=-CO*SXI

RPQW(3,3)=CXI

VP=RPQW(1,1)*VX+RPQW(1,2)*VY+RPQW(1,3)*VZ

VQ=RPQW(2,1)*VX+RPQW(2,2)*VY+RPQW(2,3)*VZ

VW=RPQW(3,1)*VX+RPQW(3,2)*VY+RPQW(3,3)*VZ

RETURN

END

APPENDIX B

```

SUBROUTINE RPQWXYZ(VP,VQ,VW,XI,W,O,RXYZ,VX,VY,VZ)
C
C THIS SUBROUTINE ROTATES A VECTOR FROM THE PQW TO THE XYZ
C COORDINATE SYSTEM
C
C VP,VQ,VW - COMPONENTS OF THE VECTOR IN THE PQW SYSTEM
C XI,W,O - INCLINATION, ARGUMENT OF PERIAPSIS, LONGITUDE OF ASCENDING
C NODE
C RXYZ - ROTATIONAL MATRIX FROM THE PQW TO THE XYZ COORDINATE SYSTEM
C VX,VY,VZ - COMPONENTS OF THE VECTOR IN THE XYZ SYSTEM
C
C DIMENSION RXYZ(3,3)
C DR=.C17453292519943
C
C Ch=cos(W*DR)
C Sh=sin(W*DR)
C CO=cos(O*DR)
C SO=sin(O*DR)
C CXI=cos(XI*DR)
C SXI=sin(XI*DR)
C
C RXYZ(1,1)=Ch*CO-Sh*SO*CXI
C RXYZ(1,2)=-Sh*CO-Ch*SO*CXI
C RXYZ(1,3)=SC*SXI
C RXYZ(2,1)=Ch*SO+Sh*CO*CXI
C RXYZ(2,2)=-Sh*SC+Ch*CO*CXI
C RXYZ(2,3)=-CO*SXI
C RXYZ(3,1)=Sh*SXI
C RXYZ(3,2)=Ch*SXI
C RXYZ(3,3)=CXI
C
C VX=RXYZ(1,1)*VP+RXYZ(1,2)*VQ+RXYZ(1,3)*VW
C VY=RXYZ(2,1)*VP+RXYZ(2,2)*VQ+RXYZ(2,3)*VW
C VZ=RXYZ(3,1)*VP+RXYZ(3,2)*VQ+RXYZ(3,3)*VW
C
C RETURN
C END

SUBROUTINE EEARTH(JD,XFE,YFE,ZFE,DXFE,DYFE,DZFE)
C
C THIS SUBROUTINE COMPUTES THE HELIOCENTRIC POSITION AND VELOCITY OF
C THE EARTH IN MEAN EQUINOX AND ECLIPTIC OF DATE COORDINATE SYSTEM.
C THIS ROUTINE CALLS SUBROUTINES TINVS AND CCNCR.
C
C JD - JULIAN DATE
C XFE,YFE,ZFE - POSITION OF EARTH
C DXFE,DYFE,DZFE - VELOCITY OF EARTH
C
C REAL JD
C ANGLE(X)=AMCD(X,360.)+180.-SIGN(180.,X)
C DR=.C17453292519943
C RC=57.2957795130823
C USUN=1.32715445E+11
C AU=149598845.

```

APPENDIX B

```

C
D=JD-2415020.
CD=D/10000.
TE=D/36525.

C
AE=1.00000023*AL
EE=C.01675104-C.00004180*TE-C.000000126*TE**2
XIE=C.C
WE=101.220833+C.CCC(47068*D+C.0000339*CD**2+0.0000007*CD**3
CE=C.C
XME=ANGLE(358.475845+C.985600267*D-C.0000112*CD**2-0.0000007*CD**
13)

C
CALL TINVS(XME*DR,EE,ECE,FE)
CALL CCNCAR(AE,EE,XIE,WE,OE,FE*RD,XHE,YHE,ZHE,DXHE,DYHE,DZHE,USUN)

C
RETURN
END

SLEA:ROUTINE EVENLS(JC,XFV,YHV,ZHV,DXHV,DYHV,DZHV)

C
THIS SUBROUTINE COMPUTES THE MEAN HELIOCENTRIC POSITION AND
C
VELCCITY OF VENUS IN THE MEAN EARTH EQUINOX AND ECLIPTIC OF DATE
C
COORDINATE SYSTEM. THIS ROUTINE CALLS SUBROUTINES TINVS AND CONCAR
C
C
JD - JULIAN DATE
C
XHV,YHV,ZHV - POSITION OF VENUS
C
DXFV,DYHV,DZHV - VELOCITY OF VENUS
C
REAL JD
ANGLE(X)=AMCD(X,360.)+180.-SIGN(180.,X)
DR=.C17453292519943
RD=57.2957795130823
LSLN=1.32715445E+11
AU=149598845.

C
D=JD-2415020.
CD=D/10000.
TE=D/36525.

C
AV=C.7233316*AU
EV=C.00682069-C.00004774*TE
XIV=3.393630+0.001005*TE-C.0000097*TE**2
CV=75.779648+C.899850*TE+C.000411*TE**2
WV=130.180500+1.408036*TE-0.000976*TE**2-CV
XMV=ANGLE(212.603219+1.6021301540*D+C.000096400*CD**2)

C
CALL TINVS(XMV*DR,EV,ECV,FV)
CALL CCNCAR(AV,EV,XIV,WV,OV,FV*RD,XHV,YHV,ZHV,DXHV,DYHV,DZHV,USUN)

C
RETURN
END

```

APPENDIX B

SUBROUTINE EMARS(JD,XHM,YHM,ZHM,DXHM,DYHM,DZHM)

THIS SUBROUTINE COMPUTES THE MEAN HELIOCENTRIC POSITION AND VELOCITY OF MARS IN THE MEAN EARTH EQUINOX AND ECLIPTIC OF DATE COORDINATE SYSTEM. THIS ROUTINE CALLS SUBROUTINES TINVS AND CCNCAR

JD - JULIAN DATE
 XHM,YHM,ZHM - POSITION OF MARS
 DXHM,DYHM,DZHM - VELOCITY OF MARS

REAL JD
 ANGLE(X)=AMCD(X,360.)*180.-SIGN(180.,X)
 DR=.C17452292519943
 RD=57.2557755130823
 USUN=1.32715445E+11
 AU=149598645.

D=JD-2415020.
 CD=C/10000.
 TE=D/36525.

AM=1.5236915*AU
 EM=C.C933129C+0.000C92064*TE-0.000000077*TE**2
 XIM=1.850334-C.CCC675*TE+0.000012*TE**2
 OM=48.786442+C.770551*TE-C.CC00015*TE**2-0.C0000576*TE**3
 WM=334.218203+1.840759*TE+C.000130*TE**2-0.C0000129*TE**3-OM
 XMM=ANGLE(319.525425+C.5240207666*D+C.000013553*CD**2+0.000000025*
 1CD**3)

CALL TINVS(XMM*DR,EM,ECM,FM)
 CALL CCNCAR(AM,EM,XIM,WM,CM,FM*RD,XHM,YHM,ZHM,DXHM,DYHM,DZHM,USUN)

RETURN
 END

SUBROUTINE SUN(SX,SY,SZ,SUNB,A,E,XI,W,O,RPQW,U,RS,KK)

THIS SUBROUTINE COMPUTES THE POSITIONS IN ORBIT WHICH CORRESPOND TO VARIOUS LIGHTING ANGLES AND WRITES OUTPUT DATA. THIS ROUTINE CALLS SUBROUTINES SUNBAND, CCNCAR, CARSPH, AND TCONIC.

SX,XY,SZ - COMPONENTS OF THE UNIT VECTOR FROM THE PLANET TOWARD THE SUN
 SUNB(1-6) - LIGHTING ANGLES. (ANGLE BETWEEN THE SUN VECTOR AND THE SPACECRAFT RADIUS VECTOR
 A,E - SEMIMAJOR AXIS, ECCENTRICITY
 XI,W,O - INCLINATION, ARGUMENT OF PERIAPSIS, LONGITUDE OF ASCENDING NODE
 RPQW - ROTATIONAL MATRIX FROM THE XYZ TO THE PQW COORDINATE SYSTEM
 U,RS - GRAVITATIONAL CONSTANT AND RADIUS OF THE PLANET
 KK - CONTROL INTEGER. 0 IMPLIES THAT XI,W,O ARE INPUT. 1 IMPLIES THAT RPQW IS INPUT.

DIMENSION RPQW(3,3),SUNB(6)
 DR=.C17453252519943
 ANGR1=SQRT(L/A**3)

APPENDIX B

```

C
WRITE(6,1C5)
C
DC 1C I=1,6
IF(SUNB(I).LT..C1) GC TO 800
CALL SUNBANC(SX,SY,SZ,SUNB(I),XI,W,O,RPQW,TA1,TA2,ITYPE1,ITYPE2,KK
1)
IF(ITYPE1.EC.C) GC TO 10
C
CALL CCNCAR(A,E,XI,W,O,TA1,X,Y,Z,DX,DY,DZ,U)
CALL CARSPH(X,Y,Z,DX,DY,DZ,R1,RA1,DEC1,V1,FPA1,AZ)
CALL TCONIC(U,E,A,TA1,T1)
T1=T1/60.
H1=R1-RS
VOH1=V1*CCS(FPA1*DR)/H1
GC TC (1,2,3,4),ITYPE1
1 WRITE(6,1C1) SUNB(I),T1,TA1,H1,DEC1,RA1,VOH1
GO TO 5
2 WRITE(6,102) SUNB(I),T1,TA1,H1,DEC1,RA1,VOH1
GO TO 5
3 WRITE(6,103) SUNB(I),T1,TA1,H1,DEC1,RA1,VOH1

GO TO 5
4 WRITE(6,104) SUNB(I),T1,TA1,H1,DEC1,RA1,VOH1
C
5 CALL CCNCAR(A,E,XI,W,O,TA2,X,Y,Z,DX,DY,DZ,U)
CALL CARSPH(X,Y,Z,CX,DY,DZ,R2,RA2,DEC2,V2,FPA2,AZ)
CALL TCONIC(U,E,A,TA2,T2)
T2=T2/60.
H2=R2-RS
VOH2=V2*CCS(FPA2*DR)/H2
GO TO (6,7,8,9),ITYPE2
6 WRITE(6,101) SUNB(I),T2,TA2,H2,DEC2,RA2,VOH2
GO TC 1C
7 WRITE(6,102) SUNB(I),T2,TA2,H2,DEC2,RA2,VOH2
GO TO 10
8 WRITE(6,103) SUNB(I),T2,TA2,H2,DEC2,RA2,VOH2
GO TO 10
9 WRITE(6,104) SUNB(I),T2,TA2,H2,DEC2,RA2,VOH2
C
10 CONTINUE
C
101 FORMAT(11H SUN ANGLEF5.1,21H DEG AND INC, S/C ASC,5F11.2,F14.8)
102 FORMAT(11H SUN ANGLEF5.1,21H DEG AND INC, S/C CSC,5F11.2,F14.8)
103 FORMAT(11H SUN ANGLEF5.1,21H DEG AND DEC, S/C ASC,5F11.2,F14.8)
104 FORMAT(11H SUN ANGLEF5.1,21H DEG AND DEC, S/C DSC,5F11.2,F14.8)
105 FORMAT(1H0,41X,62H TIME T.A. ALT DEC RA
1 V/H/)
C
800 RETURN
END

```

APPENDIX B

SUBROUTINE SUNBANC(SX,SY,SZ,PSI,XI,W,O,RPQW,TA1,TA2,ITYPE1,ITYPE2,
1KK)

C
C THIS SUBROUTINE COMPUTES THE POSITION IN ORBIT WHICH CORRESPONDS
C TO A GIVEN LIGHTING ANGLE. THIS ROUTINE CALLS SUBROUTINES RXYZPQW
C AND QADRAT
C
C SX,SY,SZ - COMPONENTS OF THE UNIT VECTOR FROM THE PLANET TOWARDS
C THE SUN
C PSI - LIGHTING ANGLE. (ANGLE BETWEEN THE SUN VECTOR AND THE
C SPACECRAFT RADIUS VECTOR)
C XI,W,O - INCLINATION, ARGUMENT OF PERIAPSIS, LONGITUDE OF
C ASCENDING NODE
C RPQW - ROTATIONAL MATRIX FROM THE XYZ TO THE PQW COORDINATE SYSTEM
C TA1,TA2 - FIRST AND SECOND TRUE ANOMALIES CORRESPONDING TO A
C LIGHTING ANGLE
C ITYPE1,ITYPE2 - CONTROL INTEGER TO INDICATE THE CONDITIONS AT TA1
C AND TA2. 0 IMPLIES NO SOLUTION. 1 IMPLIES PSI INCREASING
C SPACECRAFT ASCENDING. 2 IMPLIES PSI INCREASING, S/C
C DESCENDING. 3 IMPLIES PSI DECREASING, S/C ASCENDING.
C 4 IMPLIES PSI DECREASING, S/C DESCENDING.
C KK - CONTROL INTEGER. 0 IMPLIES THAT XI,W,O ARE INPUT AND RPQW IS
C OUTPUT. 1 IMPLIES THAT RPQW IS INPUT.
C

DIMENSION RQCW(3,3)

DR=.017453292519943

ITYPE1=0

ITYPE2=0

IF(KK.EQ.1)GO TO 1

CALL RXYZPQW(SX,SY,SZ,XI,W,O,RPQW,SP,SQ,SW)

GO TO 2

1 SP=RPQW(1,1)*SX+RPQW(1,2)*SY+RPQW(1,3)*SZ

SQ=RPQW(2,1)*SX+RPQW(2,2)*SY+RPQW(2,3)*SZ

SW=RPQW(3,1)*SX+RPQW(3,2)*SY+RPQW(3,3)*SZ

2 A=SQ**4/SP**2+2.*SQ**2+SP**2

B=-2.*CCS(PSI*DR)*(SQ**3/SP**2+SQ)

C=SW**2+SQ**2/SP**2*CCS(PSI*DR)**2-SIN(PSI*DR)**2

CALL QADRAT(A,B,C,SF1,SF2,NUM)

IF(NUM.EQ.0)GO TO 800

IF(ABS(SF1).GT.1..OR.ABS(SF2).GT.1)GO TO ECC

TA1=ATAN2(SF1,(COS(PSI*DR)-SQ*SF1)/SP)/DR

TA2=ATAN2(SF2,(CCS(PSI*DR)-SQ*SF2)/SP)/DR

SDPSI=(SP*SF1-SQ*CCS(TA1*DR))/SIN(PSI*DR)

ASDES=RPQW(2,3)*CCS(TA1*DR)-RPQW(1,3)*SF1

IF(SDPSI.GT.0..AND.ASDES.GT.0.)ITYPE1=1

IF(SDPSI.GT.0..AND.ASDES.LT.0.)ITYPE1=2

IF(SDPSI.LT.0..AND.ASDES.GT.0.)ITYPE1=3

IF(SDPSI.LT.0..AND.ASDES.LT.0.)ITYPE1=4

SDPSI=(SP*SF2-SQ*CCS(TA2*DR))/SIN(PSI*DR)

ASDES=RPQW(2,3)*CCS(TA2*DR)-RPQW(1,3)*SF2

IF(SDPSI.GT.0..AND.ASDES.GT.0.)ITYPE2=1

IF(SDPSI.GT.0..AND.ASDES.LT.0.)ITYPE2=2

IF(SDPSI.LT.0..AND.ASDES.GT.0.)ITYPE2=3

IF(SDPSI.LT.0..AND.ASDES.LT.0.)ITYPE2=4

800 CONTINUE

RETURN

END

APPENDIX B

SUEROUTINE OCCULT(A,E,XI,W,O,U,RS,EX,EY,EZ,TOCC,T1,ALT1,F1,DEC1,RA1, T2,ALT2,F2,DEC2,RA2, KK)

```

C
C THIS SUBROUTINE COMPUTES THE ENTRANCE AND EXIT TRUE ANOMALIES OF
C OCCULTATION. THIS ROUTINE CALLS SUBROUTINES RXYZPQW, QARTIC,
C CROSS, DOT, TCCNIC, RPQWXYZ, AND LATLNG.
C
C A,E,XI - SEMIMAJOR AXIS, ECCENTRICITY, INCLINATION
C W,O - ARGUMENT OF PERIAPSIS, LONGITUDE OF ASCENDING NODE
C U,RS - GRAVITATIONAL CONSTANT AND RADIUS OF THE PLANET
C EX,EY,EZ - COMPONENTS OF UNIT VECTOR TOWARD THE BODY OCCULTED
C TOCC - LENGTH OF TIME IN SHADOW
C T1,ALT1,F1,DEC1,RA1 - CONDITIONS AT ENTRY INTO THE SHADOW, TIME
C FROM PERIAPSIS, ALTITUDE, TRUE ANOMALY, DECLINATION, AND
C RIGHT ASCENSION
C T2,ALT2,F2,DEC2,RA2 - CONDITIONS AT EXIT FROM THE SHADOW
C KK - CONTROL INTEGER. 0 IMPLIES NO OCCULTATION, 1 IMPLIES OCCULT.
C
DIMENSION RPQW(3,3),CF(4),RXYZ(3,3)
ANGLE(X)=AMCD(X,360.)+180.-SIGN(180.,X)
DR=.C17453292515943
RD=57.2957795130823
F1=2000.
F2=2000.
KK=0
P=A*(1-E*E)
CALL RXYZPQW(EX,EY,EZ,XI,W,O,RPQW,BETA,XXI,ZBODY)
C1=(RS/P)**4*E**4-2.*(RS/P)**2*(XXI**2-BETA**2)*E**2+(BETA**2+XXI*
1*2)**2
C2=4.*(RS/P)**4*E**2-4.*(RS/P)**2*(XXI**2-BETA**2)*E
C3=6.*(RS/P)**4*E**2-2.*(RS/P)**2*(XXI**2-BETA**2)-2.*(RS/P)**2*(1
1.-XXI**2)*E**2+2.*(XXI**2-BETA**2)*(1.-XXI**2)-4.*BETA**2*XXI**2
C4=4.*(RS/P)**4*E-4.*(RS/P)**2*(1.-XXI**2)*E
C5=(RS/P)**4-2.*(RS/P)**2*(1.-XXI**2)+(1.-XXI**2)**2
CALL QARTIC(C1,C2,C3,C4,C5,CF(1),CF(2),CF(3),CF(4),JJ)
IF(JJ.EQ.0) GO TO EOC
C
DO 3 I=1,JJ
IF(ABS(CF(I)).LT.1.0001.AND.ABS(CF(I)).GT.1.) CF(I)=0.999999
IF(ABS(CF(I)).GT.1.) GO TO 3
SF=SQRT(1.-CF(I)**2)
R=P/(1.+E*CF(I))

CALL CROSS(R*CF(I),R*SF,0.,BETA,XXI,ZBODY,P),PY,PZ,PRODUCT)
CALL DOT(CF(I),SF,0.,BETA,XXI,ZBODY,ANG)
IF(ABS(PRODUCT-RS).LT.01.AND.ANG.GT.90.) GO TO 1
SF=-SF
CALL CROSS(R*CF(I),R*SF,0.,BETA,XXI,ZBODY,P),PY,PZ,PRODUCT)
CALL DOT(CF(I),SF,0.,BETA,XXI,ZBODY,ANG)
IF(ABS(PRODUCT-RS).LT.01.AND.ANG.GT.90.) GO TO 1
GO TO 3
1 IF(F1.LT.1000.)GO TO 2
F1=ANGLE(ATAN2(SF,(F(I))*RD)
GO TO 3
2 F2=ANGLE(ATAN2(SF,CF(I))*RD)
GO TO 4
3 CONTINUE

```

APPENDIX B

```

C
4 IF(F2.GT.1000.)GO TO 800
  CF1=COS(F1*DR)
  SF1=SIN(F1*DR)
  DSCF=2.*RS*RS*(1.+E*CF1)*(-E*SF1)+2.*P*P*(BETA*CF1+XXI*SF1)*(-BETA
1*SF1+XXI*CF1)
  IF(DSCF.GT.C.)GO TO 5
C
  TEMP=F1
  F1=F2
  F2=TEMP
C
5 CALL TCGNIC(U,E,A,F1,T1)
  CALL TCONIC(U,E,A,F2,T2)
  TCCC=T2-T1
  IF(TOCC.LT.C.)TCCC=6.2831853*SQRT(A**3/U)+TCCC
  T1=T1/60.
  T2=T2/60.
  TOCC=TOCC/60.
  AL11=P/(1.+E*CCS(F1*DR))-RS
  ALT2=P/(1.+E*CCS(F2*DR))-RS
  CALL RPQWXYZ(CCS(F1*DR),SIN(F1*DR),0.,XI,W,C,RXYZ,RX,RY,RZ)
  CALL LATLNG(RX,RY,RZ,DEC1,RA1)
  CALL RPQWXYZ(CCS(F2*DR),SIN(F2*DR),0.,XI,W,C,RXYZ,RX,RY,RZ)
  CALL LATLNG(RX,RY,RZ,DEC2,RA2)
  KK=1
  GO TO SCO
C
800 CONTINUE

  TOCC=0.
  T1=C.
  AL11=C.
  F1=C.
  DEC1=C.
  RA1=0.
  T2=C.
  ALT2=C.
  F2=0.
  DEC2=0.
  RA2=C.
900 CONTINUE
  RETURN
  END

```

APPENDIX B

```

SUBROUTINE CONCAR(A,E,XI,W,O,F,X,Y,Z,DX,DY,DZ,U)
C
C THIS SUBROUTINE CONVERTS CONIC ELEMENTS TO CARTESIAN COORDINATES
C
C A,E,XI - SEMIMAJOR AXIS, ECCENTRICITY, INCLINATION
C W,O,F - ARGUMENT OF PERIAPSIS, LONGITUDE OF ASCENDING NODE, TRUE
C ANOMALY
C X,Y,Z - COMPONENTS OF POSITION VECTOR
C DX,DY,DZ - COMPONENTS OF VELOCITY VECTOR
C U - GRAVITATIONAL CONSTANT
C
DATA DR/.017453292519943/
FR=DR*F
WFR=DR*(W+F)
OR=DR*O
XIR=DR*XI
DEN=1.+E*CCS(FR)
R=A*(1.-E*E)/DEN
V=SQRT(U*(2./R-1./A))
GAM=ATAN(E*SIN(FR)/DEN)
WFGR=WFR-GAM
CWF=CCS(WFR)
SWF=SIN(WFR)
SC=SIN(CR)
CO=CCS(OR)
SI=SIN(XIR)
CI=COS(XIR)
SWFG=SIN(WFGR)
CWFG=COS(WFGR)
X=R*(CWF*CO-SWF*SO*CI)
Y=R*(CWF*SC+SWF*CC*CI)
Z=R*SWF*SI
DX=V*(-SWFG*CO-CWFG*SO*CI)
DY=V*(-SWFG*SO+CWFG*CO*CI)
DZ=V*CWFG*SI
RETLRN
END

```

APPENDIX B

SUBROUTINE CARSPH(X,Y,Z,DX,DY,DZ,R,RAS,DEC,V,GAM,SIG)

C
C THIS SUBROUTINE CONVERTS CARTESIAN COORDINATES TO SPHERICAL
C COORDINATE.

C X,Y,Z - COMPONENTS OF POSITION VECTOR
C DX,DY,DZ - COMPONENTS OF VELOCITY VECTOR
C R,RAS,DEC - MAGNITUDE OF POSITION VECTOR, RIGHT ASCENSION,
C DECLINATION
C V,GAM,SIG - MAGNITUDE OF VELOCITY, FLIGHT-PATH ANGLE, AZIMUTH
C

```
DATA RD/57.295779513082321/
ARSN(T)=ATAN(1/SCRT(1.-T*T))
R=SQRT(X*X+Y*Y+Z*Z)
RAS=ATAN2(Y,X)
DEC=ARSN(Z/R)
V=SQRT(DX*DX+DY*DY+DZ*DZ)
CT=COS(RAS)
ST=SIN(RAS)
CP=COS(DEC)
SP=SIN(DEC)
DXP=DX*CT*CP+DY*ST*CP+DZ*SP
DYP=-DX*ST+CY*CT
DZP=-DX*SP*CT-DY*SP*ST+DZ*CP
GAM=RD*ARSN(DXP/V)
SIG=RD*ATAN2(DYP,DZP)
RAS=RC*RAS
DEC=RC*DEC
RETURN
END
```

APPENDIX B

```

SUBROUTINE TCONIC(U,EC,A,TA22,T)
C
C THIS SUBROUTINE COMPUTES THE TIME FROM PERIAPSIS PASSAGE FOR A
C GIVEN TRUE ANOMALY
C
C U - GRAVITATIONAL CONSTANT
C EC,A,TA22 - ECCENTRICITY, SEMIMAJOR AXIS, TRUE ANOMALY
C T - TIME FROM PERIAPSIS PASSAGE
C
TANGF(X)=SIN (X)/COS (X)
TA2=TA22*.174532925E-1
SLR=A*(1.-EC*EC)
AB=ABS (A)
FAC=AB*SQRT (AB/U)
ECA=(1.-EC)/(1.+EC)
ABE=SQRT (ABS (ECA))
THE=TANGF (.5*TA2)
IF (ABE-.00005) 11,11,12
12 CONTINUE
ECA=2.*ATAN (ABE*THE)
IF (A) 14,11,13
13 T=FAC*(ECA-EC*SIN (ECA))
GO TO 16
14 ANG=ABE*THE
ANG=1.+2.*ANG/(1.-ANG)
T=FAC*(EC*TANGF(ECA)-ALOG(ANG))
GO TO 16
11 FAC=SQRT (SLR**3/U)*2./((1.+EC)**2)
EC1=ECA*THE**2
T=FAC*(THE+THE**3*((1.-2.*ECA)/3.- (2.-3.*ECA)*EC1/5.+ (3.-4.*ECA)*E
1C1**2/7.- (4.-5.*ECA)*EC1**3/9.))
16 CONTINUE
RETURN
END

SUBROUTINE TINVS(M,E,EC,F)
C
C THIS SUBROUTINE CONVERTS MEAN ANOMALY TO ECCENTRIC AND TRUE
C ANOMALY
C
C M,E - MEAN ANOMALY AND ECCENTRICITY
C EC,F - ECCENTRIC AND TRUE ANOMALY
C
REAL M,MU
EC=M
10 MO=EC-E*SIN(EC)
DM=M-MO
DE=DM/(1.-E*CCS(EC))
EC=EC+DE
IF (ABS(DE).GT..0001) GO TO 10
HEC= EC/2.
HF=ATAN(SQRT((1.+E)/(1.-E))*SIN(HEC)/COS(HEC))
IF (HF.LT.C.) HF=3.1415926+HF
F=2.*HF
RETURN
END

```

APPENDIX B

```

C      SUBROUTINE CACRAT(A,B,C,X1,X2,KK)
C      THIS SUBROUTINE SOLVES THE EQUATION AX**2 +BX +C=0 FOR THE REAL
C      ROOTS
C      A,B,C - COEFFICIENTS OF THE DIFFERENT POWERS OF X
C      X1,X2 - REAL ROOT OF THE EQUATION
C      KK - NUMBER OF REAL ROOTS
C
      KK=C
      DIS=B*B-4.*A*C
      IF(DIS.LT.0.) GO TO 800
      X1=(-B+SQRT(DIS))/2./A
      X2=(-B-SQRT(DIS))/2./A
      KK=2
800 RETURN
      END

C      SUBROUTINE CUEIC(A,B,C,D,X1,X2,X3,KK)
C      THIS SUBROUTINE SOLVES THE EQUATION AX**3 +BX**2 +CX +D = 0 FOR
C      THE REAL ROOTS
C      A,B,C,D - CCEFFICIENT OF THE DIFFERENT POWERS OF X
C      X1,X2,X3 - REAL ROOTS OF THE EQUATION
C      KK - NUMBER OF REAL ROOTS
C
      CBRT(X)=SIGN(ABS(X)**.333333333,X)
      KK=0
      PI=3.1415927
      IF(A.LT..1E-30.AND.A.GT.-.1E-30) GO TO 4
      P=B/A
      C=C/A
      R=D/A
      SA=(3.*Q-P**2)/3.
      SB=(2.*P**3-9.*P*Q+27.*R)/27.
      DEL=(4.*Q**3-Q**2*P**2-18.*Q*P*R+27.*R**2+4.*P**3*R)/108.
      IF(DEL.LT..1E-30.AND.DEL.GT.-.1E-30) GO TO 3
      IF(DEL)1,3,2
1  KK=3
      CPHI=-SB/2./SQRT(SA**3/(-27.))
      IF(ABS(CPHI).GT.1.)GO TO 10
      SPHI=SQRT(1.-CPHI**2)
      PHI=ATAN2(SPHI,CPHI)
      GO TO 11
10 SPHI=SQRT((27.*DEL)/SA**3)
      SINCE FOR SMALL ANGLES SPHI=PHI
      BETA=SPHI
      IF(-SB.GT.0.)PHI=BETA
      IF(-SB.LT.0.)PHI=3.141592653589793-BETA
11 EO=2.*SQRT(-SA/3.)
      X1=EO*COS(PHI/3.)-P/3.
      X2=EO*COS(PHI/3.+2.*PI/3.)-P/3.
      X3=EO*COS(PHI/3.+4.*PI/3.)-P/3.
      GO TO 7
2  KK=1
      X1=CERT(-SB/2.+SQRT(DEL))+CBRT(-SB/2.-SQRT(DEL))-P/3.
      GO TO 7
3  KK=3
      X1=2.*CBRT(-SB/2.)-P/3.

```

APPENDIX B

```

X2=CBRT(SB/2.)-P/3.
X3=X2
GC TC 7
4 CONTINUE
DIS=C**2-4.*B*D
IF(DIS)7,5,5
5 X1=(-C+SQRT(DIS))/2./B
X2=(-C-SQRT(DIS))/2./B
KK=2
7 CONTINUE
RETURN
END

```

```

SUBROUTINE QARTIC(A,B,C,D,E,X1,X2,X3,X4,KK)

```

```

C
C THIS SUBROUTINE SOLVES THE EQUATION AX**4 +BX**3 +CX**2 +DX +E = 0
C FOR THE REAL ROOTS. THIS ROUTINE CALLS SUBROUTINES QADRAT AND CONIC
C
C A,B,C,D,E - COEFFICIENTS OF THE DIFFERENT POWERS OF X
C X1,X2,X3,X4 - REAL ROOTS OF THE EQUATION
C KK - NUMBER OF REAL ROOTS
C
C
C KK=C
C BP=B/A
C CP=C/A
C DP=D/A
C EP=E/A
C
C
C F=-EP/4.
C H2=H**2
C F3=F2*H
C H4=F3*H
C F=6.*H2+3.*EP*F+CP
C Q=4.*F3+3.*BP*F2+2.*CP*H+CP
C R=H4+BP*H3+CP*F2+DP*H+EP
C
C CALL CUBIC(1.,2.*F,F*P-4.*R,-Q*Q,T1,T2,T3,NRCOT)
C
C GO TO (1,2,3),NROOT
1 RP=T1
GO TO 4
2 RP=AMAX1(T1,T2)
GO TO 4
3 RP=AMAX1(T1,T2,T3)
C
4 CONTINUE
SQRP=SQRT(RP)
XI=(P+RP-Q/SQRP)/2.
BETA=(P+RP+Q/SQRP)/2.
C
CALL QADRAT(1.,SQRP,XI,Y1,Y2,IROOT)
CALL QADRAT(1.,-SQRP,BETA,Y3,Y4,JROOT)
IF(IROCT+JRCCT.EQ.0) GO TO 800
IF(IROCT+JRCCT.EQ.4) GO TO 6
IF(IROOT.EQ.0) GO TO 5

```

APPENDIX B

```

X1=Y1+H
X2=Y2+H
KK=2
GO TO 800
5 X1=Y3+H
  X2=Y4+H
  KK=2
  GO TO 800
6 X1=Y1+H
  X2=Y2+H
  X3=Y3+H
  X4=Y4+H
  KK=4
EOG CONTINUE
RETURN
END

```

```

SUBROUTINE CROSS(X1,Y1,Z1,X2,Y2,Z2,PX,PY,PZ,PRODUCT)

```

```

C
C THIS SUBROUTINE COMPUTES THE VECTOR OR CROSS PRODUCT
C
C X1,Y1,Z1 - COMPONENTS OF THE FIRST VECTOR
C X2,Y2,Z2 - COMPONENTS OF THE SECOND VECTOR
C PX,PY,PZ - COMPONENTS OF THE VECTOR PRODUCT
C PRODUCT - MAGNITUDE OF THE VECTOR PRODUCT
C

```

```

PX=Y1*Z2-Z1*Y2
PY=Z1*X2-X1*Z2
PZ=X1*Y2-Y1*X2
PRODUCT=SQRT(PX*PX+PY*PY+PZ*PZ)
RETURN
END

```

```

SUBROUTINE DOT(X1,Y1,Z1,X2,Y2,Z2,ANGLE)

```

```

C
C THIS SUBROUTINE COMPUTES THE ANGLE BETWEEN TWO VECTORS
C
C X1,Y1,Z1 - COMPONENTS OF THE VECTOR R1
C X2,Y2,Z2 - COMPONENTS OF THE VECTOR R2
C ANGLE - ANGLE BETWEEN VECTORS R1 AND R2
C

```

```

RD=57.295779513(823)
R1=SQRT(X1*X1+Y1*Y1+Z1*Z1)
R2=SQRT(X2*X2+Y2*Y2+Z2*Z2)

```

```

C
ANGLE=ACOS((X1*X2+Y1*Y2+Z1*Z2)/R1/R2)*RD
RETURN
END

```

APPENDIX B

SUBROUTINE CRBIT(SLAT,SLONG,VINF,HA,HP,BETA,A,E,XI,W,O,PLAT,PLONG,
IU,RS)

```

C
C THIS SUBROUTINE COMPLETES THE KEPLERIAN ORBITAL ELEMENTS FOR A
C HYPERBOLIC PERIAPSIS TO AN ELLIPTICAL PERIAPSIS TRANSFER
C
C SLAT,SLONG - LATITUDE AND LONGITUDE OF THE S-VECTOR
C VINF - HYPERBOLIC EXCESS VELOCITY
C HA,HP - APCAPSIS AND PERIAPSIS ALTITUDES OF THE ELLIPSE
C BETA - ANGULAR MEASUREMENT OF THE ORIENTATION OF THE ORBITAL PLANE
C A,E,XI - SEMIMAJOR AXIS,ECCENTRICITY, AND INCLINATION
C W,O - ARGUMENT OF PERIAPSIS AND LONGITUDE OF THE ASCENDING NODE
C PLAT,PLONG - LATITUDE AND LONGITUDE OF PERIAPSIS
C U,RS - GRAVITATIONAL CONSTANT AND RADIUS OF THE PLANET
C

  ARCCOS(X)=ACCS(X)
  ARSIN(X)=ASIN(X)
  ANGLE(X)=AMOD(X,360.)+180.-SIGN(180.,X)
  RC=57.2957795130823
  DR=.017453292519942
  XI=BETA
  IF(XI.GT.89.9999.AND.XI.LT.90.0001) XI=89.9999
  IF(XI.GT.269.9999.AND.XI.LT.270.0001) XI=269.9999
  A=(2.*RS+HA+HP)/2.
  E=(RS+HA)/A-1.
  APSHT=ARCOS(U/(U+(RS+HP)*VINF**2))*RD
  B=ARSIN(SIN(SLAT*DR)/AES(SIN(XI*DR)))*RD
  DEL=ARSIN(TAN(SLAT*DR)/ABS(TAN(XI*DR)))*RD
  IF(XI.LT.180.) GO TO 2
  W=ANGLE(180.-B-APSHT)
  IF(XI.LT.270.) GO TO 1
  O=ANGLE(180.+SLONG+DEL)
  GO TO 4
1 C=ANGLE(180.+SLONG-DEL)
  GO TO 4
2 W=ANGLE(B-APSHT)
  IF(XI.LT.90.) GO TO 3
  C=ANGLE(SLONG+DEL)
  GO TO 4
3 C=ANGLE(SLONG-DEL)
4 CONTINUE
  IF(XI.GE.180.) XI=360.-XI

  PLAT=ARSIN(SIN(W*DR)*SIN(XI*DR))*RD
  SSDEL=TAN(PLAT*DR)/TAN(XI*DR)
  CSDEL=SSDEL/TAN(W*DR)/CCS(XI*DR)
  SDEL=ATAN2(SSDEL,CSDEL)*RD
  PLONG=ANGLE(O+SDEL)
  RETURN
  END

```

APPENDIX B

```

SUBROUTINE PRECES(JD1,XE1,YE1,ZE1,JD2,XE2,YE2,ZE2)
C
C THIS SUBROUTINE TRANSFORMS MEAN EARTH EQUINOX AND EQUATOR COORDINATES
C FROM ONE EPOCH TO ANOTHER EPOCH
C
C JD1,JD2 - JULIAN DATES OF INITIAL AND FINAL EPOCH
C XE1,YE1,ZE1 - COMPONENTS OF VECTOR IN JD1 COORDINATE SYSTEM
C XE2,YE2,ZE2 - COMPONENTS OF VECTOR IN JD2 COORDINATE SYSTEM
C
REAL JD1,JD2
T=ABS((JD2-JD1)/36524.219879)
TO=(JD2-2415020.)/36524.219879
ZETA0=(0.64006944+C.38777778E-3*TO)*T+C.83888889E-4*T**2+0.5E-5*T*
1*3
CZETA0=ZETA0+C.21972222E-3*T**2
THETA0=(0.55685611-C.2369444E-3*TO)*T-C.11833333E-3*T**2-0.1166666
17E-4*T**3
C
C IF(JD2-JD1.GT.0.) GO TO 1
TEMP=ZETA0
ZETA0=-CZETA0
CZETA0=-TEMP
THETA0=-THETA0
C
1 CALL EULER(XE1,YE1,ZE1,XE2,YE2,ZE2,90.-ZETA0,-(90.+CZETA0),THETA0,
1DPI,DPSI,DPSI,XP,WP,WZP,1,0)
C
RETURN
END

SUBROUTINE LATLNG(X,Y,Z,XLAT,XLNG)
C
C THIS SUBROUTINE COMPUTES THE LATITUDE AND LONGITUDE OF A GIVEN
C POSITION VECTOR
C
C X,Y,Z - COMPONENTS OF THE POSITION VECTOR
C XLAT,XLNG - LATITUDE AND LONGITUDE
C
ARCCS(X)=ACCS(X)
ARSIN(X)=ASIN(X)
RD=57.2957795
R=SQRT(X**2+Y**2+Z**2)
XLNG=ATAN2(Y,X)*RD
XLAT=ARSIN(Z/R)*RD
RETURN
END

```

APPENDIX B

SUBROUTINE EULER(X,Y,Z,XP,YP,ZP,PHI,PSI,THETA,DPHI,DPSI,DTHETA,WXP
1,WYP,WZP,J,K)

```

C
C   THIS SUBROUTINE PERFORMS AN EULER ROTATION AND/OR COMPUTES THE
C   INSTANTANEOUS ANGULAR VELOCITY VECTOR
C
C   X,Y,Z - COMPONENTS OF THE VECTOR IN THE UNPRIMED COORDINATE SYSTEM
C   XP,YP,ZP - COMPONENTS OF THE VECTOR IN THE PRIMED COORDINATE SYSTEM
C   PHI,PSI,THETA - THE THREE EULER ANGLES
C   DPHI,DPSI,DTHETA - TIME RATE OF CHANGE OF THE EULER ANGLES
C   WXP,WYP,WZP - THE PRIMED COMPONENTS OF THE INSTANTANEOUS ANGULAR
C                   VELOCITY VECTOR
C   J - CONTROL INTEGER. -1 IMPLIES XP,YP,ZP INPUT, X,Y,Z OUTPUT.
C       0 IMPLIES NO ROTATION. 1 IMPLIES X,Y,P INPUT, XP,YP,ZP OUTPUT.
C   K - CONTROL INTEGER. -1 IMPLIES WXP,WYP,WZP INPUT, DPHI,DPSI,
C       DTHETA OUTPUT. 0 IMPLIES NO ANGULAR VELOCITY COMPUTATIONS.
C       1 IMPLIES DPHI,DPSI,DTHETA INPUT, WXP,WYP,WZP OUTPUT.
C
      XPHI=PHI*.0174532925
      XPSI=PSI*.0174532925
      XTH=THETA*.0174532925
      IF(J)10,12,11
10  X=(COS(XPSI)*COS(XPHI)-COS(XTH)*SIN(XPHI)*SIN(XPSI))*XP+(-SIN(XPSI)
      1)*COS(XPHI)-COS(XTH)*SIN(XPHI)*COS(XPSI))*YF+(SIN(XTH)*SIN(XPHI))*
      2ZP
      Y=(COS(XPSI)*SIN(XPHI)+COS(XTH)*COS(XPHI)*SIN(XPSI))*XP+(-SIN(XPSI)
      1)*SIN(XPHI)+COS(XTH)*COS(XPHI)*COS(XPSI))*YF+(-SIN(XTH)*COS(XPHI))
      2*ZP
      Z=(SIN(XTH)*SIN(XPSI))*XP+(SIN(XTH)*COS(XPSI))*YP+(COS(XTH))*ZP
      GO TO 12
11  XP=(COS(XPSI)*COS(XPHI)-COS(XTH)*SIN(XPHI)*SIN(XPSI))*X+(COS(XPSI)
      1)*SIN(XPHI)+COS(XTH)*COS(XPHI)*SIN(XPSI))*Y+(SIN(XTH)*SIN(XPSI))*Z
      YP=(-SIN(XPSI)*COS(XPHI)-COS(XTH)*SIN(XPHI)*COS(XPSI))*X+(-SIN(XPSI)
      1)*SIN(XPHI)+COS(XTH)*COS(XPHI)*COS(XPSI))*Y+(COS(XPSI)*SIN(XTH))*
      2Z
      ZP=(SIN(XTH)*SIN(XPHI))*X+(-SIN(XTH)*COS(XPHI))*Y+COS(XTH)*Z
12  IF(K)13,15,14
13  DPHI=(WXP*SIN(XPSI)+WYP*COS(XPSI))/SIN(XTH)
      DPSI=WZP-(COS(XTH)*(WXP*SIN(XPSI)+WYP*COS(XPSI)))/SIN(XTH)
      DTHETA=WXP*COS(XPSI)-WYP*SIN(XPSI)
      GO TO 15
14  WXP=DPHI*SIN(XTH)*SIN(XPSI)+DTHETA*COS(XPSI)

      WYP=DPHI*SIN(XTH)*COS(XPSI)-DTHETA*SIN(XPSI)
      WZP=DPSI+DPHI*COS(XTH)
15  RETURN
      END

```

APPENDIX B

SLBRROUTINE VECTOR(JD,DECS,RAS,DECE,RAE,DECC,RAC,SX,SY,SZ,EX,EY,EZ,
1CX,CY,CZ,IBODY)

THIS SUBROUTINE COMPUTES THE POSITION OF THE SUN, EARTH, AND
CANOPUS IN THE PLANETOCENTRIC, PLANET EQUATOR, COORDINATE SYSTEM AND
WRITES DATA. THIS ROUTINE CALLS SUBROUTINES EEARTH, EMARS, EVENUS, PRECES
LATLNG, DOT, RECEQ, REQVEC, AND REQMEQ.

JD - JULIAN DATE AT TIME OF INTEREST
IBODY - CONTROL INTEGER. 2 IMPLIES VENUS, 4 IMPLIES MARS.
DECS,RAS - DECLINATION AND RIGHT ASCENSION OF THE SUN.
DECE,RAE - DECLINATION AND RIGHT ASCENSION OF THE EARTH.
DECC,RAC - DECLINATION AND RIGHT ASCENSION OF CANOPUS.
SX,SY,SZ - UNIT VECTOR FROM THE PLANET TO THE SUN.
EX,EY,EZ - UNIT VECTOR FROM THE PLANET TO THE EARTH.
CX,CY,CZ - UNIT VECTOR FROM THE PLANET TO CANOPUS.

REAL JD
RC=57.2957795130823

CALL EEARTH(JD,XHE,YHE,ZHE,DXHE,DYHE,DZHE)
CALL PRECES(2432282.,-.66340592,.60342839,-.79513092,JD,CXE,CYE,C
1ZE)

IF(IBODY.EQ.4) GO TO 2
IF(IBODY.EQ.2) GO TO 1

1 CALL EVENUS(JD,XFP,YFP,ZHP,DXHP,DYHP,DZHP)
GO TO 3

2 CALL EMARS(JD,XFP,YFP,ZHP,CXHP,DYHP,DZHP)

3 XHPE=XHE-XHP
YHPE=YHE-YFP
ZHPE=ZHE-ZHP
RSE=SQRT(XHE**2+YHE**2+ZHE**2)
RSP=SQRT(XHP**2+YFP**2+ZHP**2)
RFE=SQRT(XHPE**2+YHPE**2+ZHPE**2)
SEX=XHE/RSE
SEY=YHE/RSE
SEZ=ZHE/RSE
SPX=XHP/RSP
SPY=YFP/RSP
SPZ=ZHP/RSP

PEX=XHPE/RPE
PEY=YHPE/RPE
PEZ=ZHPE/RPE

CALL LATLNG(SEX,SEY,SEZ,EFLAT,EHLONG)
CALL LATLNG(SPX,SPY,SPZ,PFLAT,PHLONG)
CALL DOT(SEX,SEY,SEZ,SPX,SPY,SPZ,ESP)
CALL DOT(SEX,SEY,SEZ,PEX,PEY,PEZ,SEP)
CALL DCT(SPX,SPY,SPZ,-PEX,-PEY,-PEZ,SPE)
CALL RECEQ(JD,-SPX,-SPY,-SPZ,SXE,SYE,SZE)
CALL RECEQ(JD,PEX,PEY,PEZ,EXE,EYE,EZE)

APPENDIX B

```

      IF( IBODY.EQ.2) GC TC 4
      IF( IBODY.EQ.4) GO TC 5
4  CALL REQVEC(JD,SXE,SYE,SZE,SX,SY,SZ,DECS,RAS)
   CALL REQVEC(JC,EXE,EYE,EZE,EX,EY,EZ,DECE,RAE)
   CALL REQVEC(JC,CXE,CYE,CZE,CX,CY,CZ,DECC,RAC)
   GC TC 6
5  CALL REQMEQ(JD,SXE,SYE,SZE,SX,SY,SZ,DECS,RAS)
   CALL REQMEQ(JC,EXE,EYE,EZE,EX,EY,EZ,DECE,RAE)
   CALL REQMEQ(JC,CXE,CYE,CZE,CX,CY,CZ,DECC,RAC)
C
6  XPS=SX*RSP
   YPS=SY*RSP
   ZPS=SZ*RSP
   XPE=EX*RPE
   YPE=EY*RPE
   ZPE=EZ*RPE
C
      IF( IBODY.EQ.2) GC TC 7
      IF( IBODY.EQ.4) GC TC 8
7  WRITE(6,101) XHP,YHP,ZHP,PHLAT,PHLONG,XHE,YHE,ZHE,EHLAT,EHLONG
   WRITE(6,102) XFS,YFS,ZPS,DECS,RAS,XPE,YPE,ZFE,DECE,RAE
   WRITE(6,103) SX,SY,SZ,EX,EY,EZ,CX,CY,CZ
   WRITE(6,104) RPE,RSE,RSP,SEP,ESP,SPE
   GC TC 800
8  WRITE(6,105) XHP,YHP,ZHP,PHLAT,PHLONG,XHE,YHE,ZHE,EHLAT,EHLONG
   WRITE(6,106) XFS,YFS,ZPS,DECS,RAS,XPE,YPE,ZFE,DECE,RAE
   WRITE(6,107) SX,SY,SZ,EX,EY,EZ,CX,CY,CZ
   WRITE(6,108) RPE,RSE,RSP,SEP,ESP,SPE
C
101 FORMAT(*HELIOCENTRIC ECLIPTIC (MEAN EQUINOX OF DATE)*//24X,*X (
      1KM)*,8X,*Y (KM)*,9X,*Z (KM)*,9X,*LATITUDE*,7X,*LONGITUDE*//* VENU
      2S*,5X,5E16.7//* EARTH*,5X,5E16.7)

102 FORMAT(*GALACTIC (VENUS EQUATOR, VENUS EQUINOX)*//24X,*X (
      1 KM)*,8X,*Y (KM)*,9X,*Z (KM)*,6X,* DECLINATION RIGHT ASCENSION*
      2//* SUN*,7X,5E16.7//* EARTH*,5X,5E16.7)
103 FORMAT(14HC UNIT VECTORS//12H SUN 3E16.7//12H EARTH 3E
      116.7//12H CANOPLS 3E16.7)
104 FORMAT(29HOVENUS-EARTH DISTANCE (KM) = E16.8//29H SUN-EARTH DISTAN
      1CE (KM) = E16.8//29H SUN-VENUS DISTANCE (KM) = E16.8//29H VENU
      2S-EARTH-SUN ANGLE = E16.8//29H VENUS-SUN-EARTH ANGLE = E16
      3.8//29H EARTH-VENUS-SUN ANGLE = E16.8)
105 FORMAT(*HELIOCENTRIC ECLIPTIC (MEAN EQUINOX OF DATE)*//24X,*X (
      1KM)*,8X,*Y (KM)*,9X,*Z (KM)*,9X,*LATITUDE*,7X,*LONGITUDE*//* MARS
      2*,6X,5E16.7//* EARTH*,5X,5E16.7)
106 FORMAT(*OAREOCENTRIC (MARS EQUATOR, MARS EQUINOX)*//24X,*X (KM)*
      1,8X,*Y (KM)*,9X,*Z (KM)*,6X,* DECLINATION RIGHT ASCENSION*//* S
      2UN*,7X,5E16.7//* EARTH*,5X,5E16.7)
107 FORMAT(14HO UNIT VECTORS//12H SUN 3E16.7//12H EARTH 3E
      116.7//12H CANOPLS 3E16.7)
108 FORMAT(28HCMARS-EARTH DISTANCE (KM) = E16.8//28H SUN-EARTH DISTANC
      1E (KM) = E16.8//28H SUN-MARS DISTANCE (KM) = E16.8//28H MARS-EA
      2RTH-SUN ANGLE = E16.8//28H MARS-SUN-EARTH ANGLE = E16.8//2
      38H EARTH-MARS-SUN ANGLE = E16.8)
C
ECC RETURN
END

```

APPENDIX C

INPUTS AND OUTPUTS

The definitions of all input and output parameters are given in this appendix along with a sample input and the corresponding program output.

Definition of Input

Definitions of the program input follow:

Program symbol	Mathematical symbol	Units	Definition
JD	JD_a	day	Julian date of arrival at planet
SVDECE	$\delta_{S,EE}$	deg	Declination of the incoming hyperbolic asymptote at the planet in the Earth equinox and equator coordinate system
SVRAE	$\lambda_{S,EE}$	deg	Right ascension of the incoming hyperbolic asymptote at the planet in the Earth equinox and equator coordinate system
VINF	V_∞	km/sec	Hyperbolic excess velocity at the planet
HA	h_a	km	Apoapsis altitude of the orbit about the planet
HP	h_p	km	Periapsis altitude of the orbit about the planet
BFRST	β_f	deg	The first orientation angle of the orbital plane to be considered where $0^\circ \leq \beta_f \leq 360^\circ$. (See fig. 1.) If an iteration is performed on β , the value of β_f must be an integer. A rational value may be input if only one inclination is considered.
BLAST	β_l	deg	The last orientation angle to be considered where $0^\circ \leq \beta_l \leq 360^\circ$ and is an integer; β_l need not be input if only one inclination is considered.
BSTEP	$\Delta\beta$	deg	Orientation step size where $\Delta\beta \geq 0$; $\Delta\beta$ must not be input if only one inclination is considered.
TLAST	t_l	day	The last time in the planet orbit to be considered where t_l is measured from arrival; t_l is considered zero if not input.
TSTEP	Δt	day	Time step size in the planet orbit; Δt need only be input if t_l is input.
XJ20	J_{20}	none	Second zonal harmonic of the planet; J_{20} is considered zero if not input. (For Mars, $J_{20} = 0.002075$.)
IBODY	IBODY	none	Integer indicator IBODY = 2 for Venus IBODY = 4 for Mars
SUN1	ψ_1	deg	First Sun angle. The angle between the planet-Sun vector and the planet-spacecraft vector where $0^\circ \leq \psi$; ψ need only be input if Sun angle date is desired, in which case up to six different values of ψ may be input.
SUN2	ψ_2	deg	Second Sun angle
SUN3	ψ_3	deg	Third Sun angle
SUN4	ψ_4	deg	Fourth Sun angle
SUN5	ψ_5	deg	Fifth Sun angle
SUN6	ψ_6	deg	Sixth Sun angle

APPENDIX C

Sample Input

The program input is loaded by using a FORTRAN IV namelist. A sample set of input data is as follows:

```

$CASE JD = 2441533.5,
      SVDECE = 62.94,
      SVRAE = 120.12,
      VINP = 4.33,
      HA = 20000,
      HP = 1000,
      BFRST = 0,
      BLAST = 60,
      BSTEP = 10,
      IBODY = 2,
      SUN1 = 60, SUN2 = 70, SUN3 = 80, SUN4 = 90$
    
```

Definition of Output

Definitions of the program output follow:

Program symbol	Mathematical symbol	Units	Definition
Julian date	JD_C	day	Current Julian date
Arrival date			The calendar date of arrival at the planet
SVDECE	$\delta_{S,EE}$	deg	Defined under input (see SVDECE)
SVRAE	$\lambda_{S,EE}$	deg	Defined under input (see SVRAE)
VINF	V_∞	km/sec	Defined under input (see VINF)

The following output parameters are referenced to the mean planet equinox and equator of date coordinate system. They are listed in the same order in which they appear in the sample output.

Program symbol	Mathematical symbol	Units	Definition
SVDECP	$\delta_{S,PE}$	deg	Declination of the incoming hyperbolic asymptote at the planet
SVRAP	$\lambda_{S,PE}$	deg	Right ascension of the incoming hyperbolic asymptote at the planet

APPENDIX C

Program symbol	Mathematical symbol	Units	Definition
HA	h_a	km	Defined under input (see HA)
HP	h_p	km	Defined under input (see HP)
JD	JD_c	day	Current Julian date
PLAT	δ_p	deg	Latitude of periapsis
PLONG	λ_p	deg	Longitude of periapsis
PX	P_X	none	X-component of the P unit vector of the PQW triad
PY	P_Y	none	Y-component
PZ	P_Z	none	Z-component
QX	Q_X	none	X-component of the Q unit vector of the PQW triad
QY	Q_Y	none	Y-component
QZ	Q_Z	none	Z-component
WX	W_X	none	X-component of the W unit vector of the PQW triad
WY	W_Y	none	Y-component
WZ	W_Z	none	Z-component
VELSUN	α	deg	Angle between velocity vector at periapsis and the Sun vector
SMA	a	km	Semimajor axis of orbit about the planet
ECC	e	none	Eccentricity
INC	i	deg	Inclination
ARGPER	ω	deg	Argument of periapsis
ARGNOD	Ω	deg	Longitude of ascending node
DECSUN	δ_{\odot}	deg	Declination of the Sun
RASUN	λ_{\odot}	deg	Right ascension of the Sun
DECETH	δ_{\oplus}	deg	Declination of the Earth
RAETH	λ_{\oplus}	deg	Right ascension of the Earth

APPENDIX C

Program symbol	Mathematical symbol	Units	Definition
XSUN	x_{\odot}	none	X-component of the unit vector from the planet toward the Sun
YSUN	y_{\odot}	none	Y-component
ZSUN	z_{\odot}	none	Z-component
XEARTH	x_{\oplus}	none	X-component of the unit vector from the planet toward the Earth
YEARTH	y_{\oplus}	none	Y-component
ZEARTH	z_{\oplus}	none	Z-component
PERIOD	p	hour	Period of the orbit about the planet
XCANPS	x_c	none	X-component of the unit vector from the planet toward the star Canopus
YCANPS	y_c	none	Y-component
ZCANPS	z_c	none	Z-component
ZAP	ZAP	deg	Angle at the planet between the Sun vector and the incoming hyperbolic asymptote (S-vector)
SVP	ϕ	deg	Angle between incoming hyperbolic asymptote and the vector from the planet to periapsis
VPE	V_{pe}	km/sec	Velocity at periapsis of the elliptical orbit about the planet
VAE	V_{ae}	km/sec	Velocity at apoapsis of the elliptical orbit about the planet
VPH	V_{ph}	km/sec	Velocity at periapsis on the hyperbola
DELV	ΔV	km/sec	Deboost velocity ($V_{ph} - V_{pe}$)
XJ20	J_{20}	none	Defined under input (see XJ20)
TIME	t	min	Time in orbit measured from periapsis to the point in question
T.A.	f	deg	True anomaly of the point in question

APPENDIX C

Program symbol	Mathematical symbol	Units	Definition
ALT	h	km	Altitude of the point in question
DEC	δ	deg	Declination of the point in question
RA	λ	deg	Right ascension of the point in question
V/H	V/h	sec^{-1}	Ratio of horizontal velocity to altitude at point in question

Sample Output

Samples of the output as received from the program follow:

```

JULIAN DATE          2441533.5
      YEAR      MONTH      DAY
CALENDAR DATE        72      8      4
ARRIVAL DATE         72      8      4
HELIOCENTRIC ECLIPTIC (MEAN EQUINOX OF DATE)
      X (KM)      Y (KM)      Z (KM)      LATITUDE      LONGITUDE
VENUS      1.0302678E+08 -3.4509782E+07 -6.4203809E+06 -3.3817195E+00 -1.8518755E+01
EARTH      1.0098493E+08 -1.1329869E+08  0.              0.              -4.8288874E+01
APHEROICENTRIC (VENUS EQUATOR, VENUS EQUINOX)
      X (KM)      Y (KM)      Z (KM)      DECLINATION  RIGHT ASCENSION
SUN        -8.1802037E+07  7.1372691E+07  7.8121254E+06  4.1159245E+00  1.3889514E+02
EARTH      -3.2698443E+07 -7.1997858E+07 -4.5053729E+05 -3.2644396E-01 -1.1442558E+02
UNIT VECTORS
SUN        -7.5156421E-01  6.5574357E-01  7.1774666E-02
EARTH      -4.1350426E-01 -9.1048436E-01 -5.6974911E-02
CAMPUS     8.1255059E-02  3.1303492E-01 -9.4625934E-01
VENUS-EARTH DISTANCE (KM) = 7.90764357E+07
SUN-EARTH DISTANCE (KM) = 1.51771370E+08
SUN-VENUS DISTANCE (KM) = 1.08842379E+08
VENUS-EARTH-SUN ANGLE = 4.33567363E+01
VENUS-SUN-EARTH ANGLE = 2.99440750E+01
EARTH-VENUS-SUN ANGLE = 1.06659189E+02

```

BETA = 50.CCCC (VENUS EQUATOR, VENUS EQUINOX)
 TIME PAST ARRIVAL = 0.0 DAYS

SVDECE= 6.29400000E+01	SVRAE = 1.20120000E+02	VINF = 4.33000000E+00	SVDECP= 4.57515624E+01
SVRAP = 8.70988412E+01	HA = 2.00000000E+04	HP = 1.00000000E+03	JD = 2.44153350E+06
PLAT = 1.84920348E+01	PLONG = 4.39216827E+01	PX = 6.83098535E-01	PY = 6.57858492E-01
FZ = 3.17172819E-01	QX = -6.28135792E-01	QY = 3.26431033E-01	QZ = 6.97298711E-01
WX = 3.55188827E-01	WY = -6.78723055E-01	WZ = 6.42787610E-01	VELSUN= 4.19521438E+01
SMA = 1.65850000E+04	ECC = 5.72806753E-01	INC = 5.00000000E+01	ARGPER= 2.44588570E+01
ARGNOO= 2.76239274E+01	DECSUN= 4.11592452E+00	RASUN = 1.38895138E+02	DECETH= -3.26443962E-01
RAETH = -1.14425580E+02	XSUN = -7.51564211E-01	YSUN = 6.55743573E-01	ZSUN = 7.17746656E-02
XEARTH= -4.13504260E-01	YEARTH= -9.10484358E-01	ZEARTH= -5.69749114E-03	PERIOD= 6.54043860E+00
XCANPS= 8.12550588E-02	YCANPS= 3.13034915E-01	ZCANPS= -9.46259344E-01	ZAP = 6.11941244E+01
SVP = 4.47839227E+01	VPE = 8.49202890E+00	VAE = 2.30653727E+00	VPH = 1.05095498E+01
DELV = 2.01752085E+00	XJ20 = 0.		

	TIME	T.A.	ALT	DEC	RA	V/H
SUN ANGLE 60.0 DEG AND DEC, S/C ASC	12.30	46.64	1912.76	46.45	89.58	.00393299
SUN ANGLE 60.0 DEG AND INC, S/C CSC	91.32	142.47	14334.23	9.97	-160.86	.00020556
SUN ANGLE 70.0 DEG AND DEC, S/C ASC	8.03	31.84	1410.80	39.59	71.57	.00568941
SUN ANGLE 70.0 DEG AND INC, S/C CSC	126.21	157.27	17539.44	-1.32	-151.27	.00014520
SUN ANGLE 80.0 DEG AND DEC, S/C ASC	4.42	18.01	1128.78	31.15	58.10	.00738890
SUN ANGLE 80.0 DEG AND INC, S/C CSC	167.23	171.10	19585.12	-11.85	-142.23	.00011967
SUN ANGLE 90.0 DEG AND DEC, S/C ASC	1.11	4.55	1008.16	21.81	47.24	.00841363
SUN ANGLE 90.0 DEG AND INC, S/C CSC	-181.27	-175.45	19890.03	-21.81	-132.76	.00011646
SUN OCCULTATION TIME	0.00					
ENTER SUN OCCULTATION	0.00	0.00	0.00	0.00	0.00	
EXIT SUN OCCULTATION	0.00	0.00	0.00	0.00	0.00	
EARTH OCCULTATION TIME	22.97					
ENTER EARTH OCCULTATION	-10.97	317.75	1740.23	-13.53	15.97	
EXIT EARTH OCCULTATION	11.99	45.63	1871.47	46.08	88.23	
CANCPUS OCCULTATION TIME	0.00					
ENTER CANCPUS OCCULTATION	0.00	0.00	0.00	0.00	0.00	
EXIT CANCPUS OCCULTATION	0.00	0.00	0.00	0.00	0.00	

APPENDIX C

BETA = 60.0000 (VENUS EQUATOR, VENUS EQUINOX)
 TIME PAST ARRIVAL = 0.0 DAYS

```

SVDECE= 6.2940000E+01  SVRAE = 1.20120000E+02  VINF = 4.33000000E+00  SVDECP= 4.57515624E+01
SVRAP = 8.70988412E+01  HA = 2.00000000E+04  HP = 1.00000000E+03  JC = 2.44153350E+06
PLAT = 5.53023077E+00  PLONG = 5.63123976E+01  PX = 5.47009130E-01  PY = 8.20590189E-01
PZ = 1.65567973E-01  QX = -5.01016087E-01  QY = 1.62467333E-01  QZ = 8.50051320E-01
WX = 6.70644386E-01  WY = -5.47938051E-01  WZ = 5.00000000E-01  VELSUN= 5.70371716E+01
SMA = 1.65850000E+04  ECC = 5.72806753E-01  INC = 6.00000000E+01  ARGPER= 1.10217390E+01
ARGNCC= 5.07500715E+01  DEC SUN= 4.11592452E+00  RASUN = 1.38895138E+02  DECETH= -3.26443962E-01
RAETH = -1.14425580E+02  XSUN = -7.51564211E-01  YSUN = 6.55743573E-01  ZSUN = 7.17746656E-02
XEARTH= -4.13504260E-01  YEARTH= -9.10484358E-01  ZEARTH= -5.69749114E-03  PERIOD= 6.54043860E+00
XCANPS= 8.12550588E-02  YCANPS= 3.13034915E-01  ZCANPS= -9.46259344E-01  ZAP = 6.11941244E+01
SVP = 4.47839327E+01  VPE = 8.49202890E+00  VAE = 2.30653727E+00  VPH = 1.05095498E+01
LELV = 2.01752085E+00  XJ20 = 0.

```

	TIME	T.A.	ALT	DEC	RA	V/H
SUN ANGLE 60.0 DEG AND INC, S/C CSC	39.46	102.76	6671.89	52.42	-177.86	.00070690
SUN ANGLE 60.0 DEG AND DEC, S/C ASC	12.92	48.61	1997.22	48.35	91.22	.00372731
SUN ANGLE 70.0 DEG AND INC, S/C CSC	66.78	128.16	11162.31	34.48	-152.61	.00031252
SUN ANGLE 70.0 DEG AND DEC, S/C ASC	5.75	23.21	1215.08	29.15	69.54	.00678292
SUN ANGLE 80.0 DEG AND INC, S/C CSC	102.41	147.67	15510.85	18.34	-140.29	.00017962
SUN ANGLE 80.0 DEG AND DEC, S/C ASC	.90	3.70	1005.37	12.71	58.23	.00844028
SUN ANGLE 90.0 DEG AND INC, S/C CSC	150.38	155.68	18957.04	2.85	-130.90	.00012674
SUN ANGLE 90.0 DEG AND DEC, S/C ASC	-3.50	-14.32	1081.06	-2.85	49.10	.00776639
SUN OCCULTATION TIME	0.00					
ENTER SUN OCCULTATION	0.00	0.00	0.00	0.00	0.00	
EXIT SUN OCCULTATION	0.00	0.00	0.00	0.00	0.00	
EARTH OCCULTATION TIME	25.38					
ENTER EARTH OCCULTATION	-13.42	309.81	2068.20	-33.16	28.59	
EXIT EARTH OCCULTATION	11.96	45.52	1867.02	46.26	87.86	
CANOPUS OCCULTATION TIME	0.00					
ENTER CANOPUS OCCULTATION	0.00	0.00	0.00	0.00	0.00	
EXIT CANOPUS OCCULTATION	0.00	0.00	0.00	0.00	0.00	

REFERENCES

1. Clarke, V. C., Jr.; Roth, R. Y.; et al.: Earth-Venus Trajectories, 1964-1970. Tech. Mem. No. 33-99, Vols. I to V, Jet Propulsion Lab., California Inst. Technol., 1963.
2. Clarke, V. C., Jr.; Roth, R. Y.; et al.: Earth-Mars Trajectories, 1964-1977. Tech. Mem. No. 33-100, Vols. I to VII, Jet Propulsion Lab., California Inst. Technol., 1964.
3. Koenig, L. R.; Murray, F. W.; Michaux, C. M.; and Hyatt, H. A.: Handbook of the Physical Properties of the Planet Venus. NASA SP-3029, 1967.
4. Anon.: Explanatory Supplement to the Astronomical Ephemeris and the American Ephemeris and Nautical Almanac. H. M. Nautical Almanac Office, 1961.
5. Kozai, Yoshihide: The Motion of a Close Earth Satellite. Astron. J., vol. 64, no. 9, Nov. 1959, pp. 367-377.
6. Clarke, Victor C., Jr.: Constants and Related Data for Use in Trajectory Calculations as Adopted by the Ad Hoc NASA Standard Constants Committee. Tech. Rep. No. 32-604 (Contract No. NAS 7-100), Jet Propulsion Lab., California Inst. Technol., Mar. 6, 1964.
7. Michaux, C. M.: Handbook of the Physical Properties of the Planet Mars. NASA SP-3030, 1967.
8. Escobal, Pedro Ramon: Methods of Orbit Determination. John Wiley & Sons, Inc., 1965.

FIRST CLASS MAIL

POSTMASTER: If Undeliverable (Section 15E
Postal Manual) Do Not Return

"The aeronautical and space activities of the United States shall be conducted so as to contribute . . . to the expansion of human knowledge of phenomena in the atmosphere and space. The Administration shall provide for the widest practicable and appropriate dissemination of information concerning its activities and the results thereof."

— NATIONAL AERONAUTICS AND SPACE ACT OF 1958

NASA SCIENTIFIC AND TECHNICAL PUBLICATIONS

TECHNICAL REPORTS: Scientific and technical information considered important, complete, and a lasting contribution to existing knowledge.

TECHNICAL NOTES: Information less broad in scope but nevertheless of importance as a contribution to existing knowledge.

TECHNICAL MEMORANDUMS: Information receiving limited distribution because of preliminary data, security classification, or other reasons.

CONTRACTOR REPORTS: Scientific and technical information generated under a NASA contract or grant and considered an important contribution to existing knowledge.

TECHNICAL TRANSLATIONS: Information published in a foreign language considered to merit NASA distribution in English.

SPECIAL PUBLICATIONS: Information derived from or of value to NASA activities. Publications include conference proceedings, monographs, data compilations, handbooks, sourcebooks, and special bibliographies.

TECHNOLOGY UTILIZATION PUBLICATIONS: Information on technology used by NASA that may be of particular interest in commercial and other non-aerospace applications. Publications include Tech Briefs, Technology Utilization Reports and Notes, and Technology Surveys.

Details on the availability of these publications may be obtained from:

SCIENTIFIC AND TECHNICAL INFORMATION DIVISION
NATIONAL AERONAUTICS AND SPACE ADMINISTRATION
Washington, D.C. 20546